

ASTM CATEGORY 5 : GRAVITY RIDING FOCUSED ON THE DESCENT

For a longer longevity of the wheel, Mavic recommends that the total weight supported by the wheels doesn't exceed 150kg, bike included

Recommended tyre sizes: 60mm to 76mm (2.35" to 3.0")

Maximum tyre pressure: 3.2bar/46PSI with a 47mm tyre - 2.85bar/41PSI with a 64mm tyre

REFERENZEN RÄDER

F92171 Deemax 29 21 Ft

F92181 DEEMAX INT 29 BST

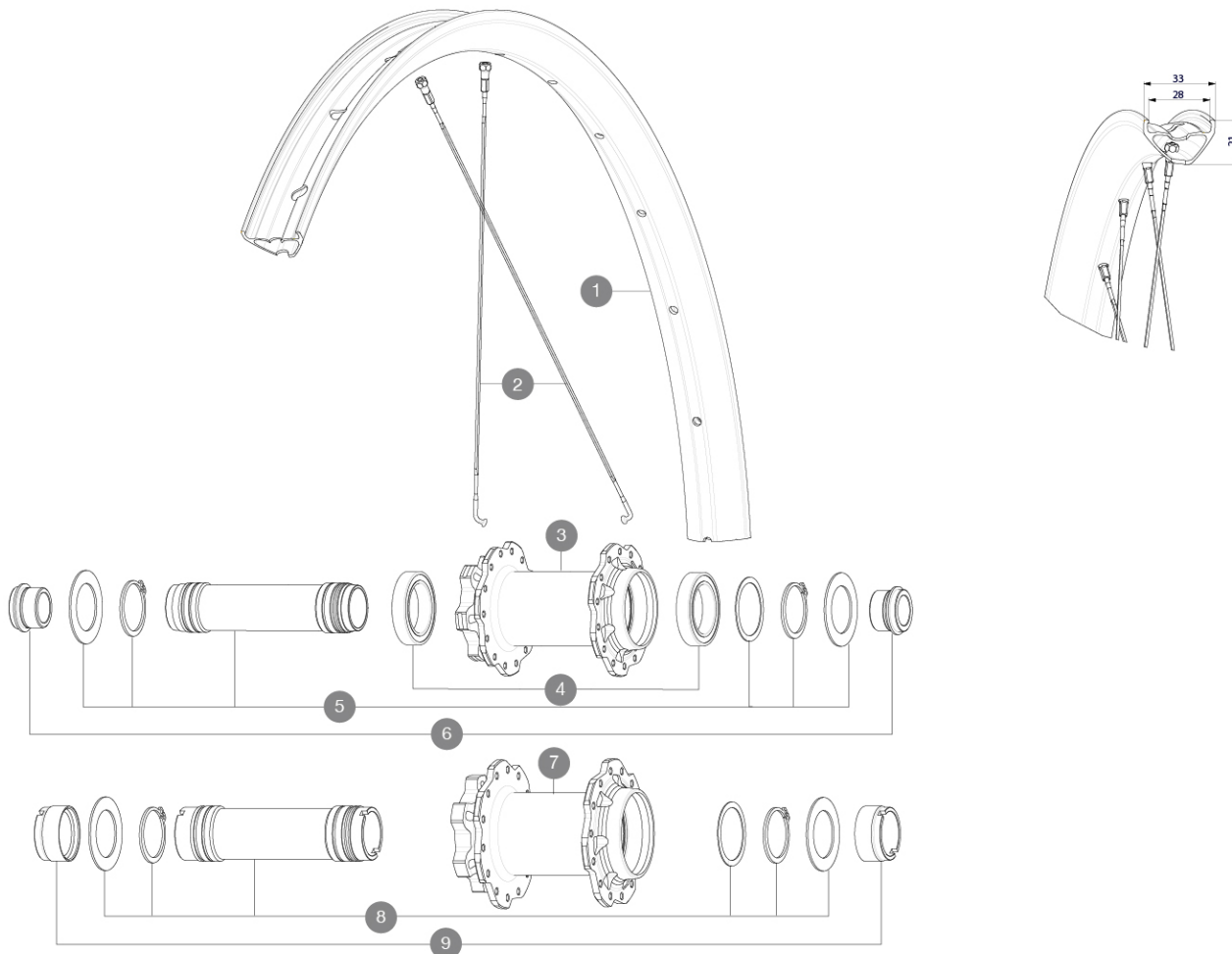

RIMS



&NBSP;:

1	V3766215	Kit Front/Rear rim Deemax 21 29"
	V2640101	UST RIM TAPE 32mm for 28 to 29mm wide rims

SPOKES

2	V2387901	KIT 14 J BENT STEEL SPOKES 299mm DEEMAX DH 29" + black steel
---	----------	--







HUB SHELLS

3	N/A	NABENKÖRPER
4	M40179	FRONT BEARING 25x37x7 20mm AXLE
5	V2373701	KIT 20x110mm BOOST AXLE QRM AUTO MTB > 2019
7	N/A	NABENKÖRPER
8	V2373801	KIT 20x110mm AXLE QRM AUTO MTB > 2019

ADAPTERS

6	12982801	15mm ADAPTER KIT - 2012 WHEELS
9	12982901	20mm adapter for Crossmax ST/SX (front wheel)

GELIEFERT MIT

2 replacement spokes with each wheel	
Boost-Adapter (20x110 mm)  im Lieferumfang eines Boost-VR enthalten	
HR-Achsstummel 12x150 mm  bei HR mit 12x157-mm-Achse im Lieferumfang enthalten	
Non-Boost-Adapter (20x110 mm)  im Lieferumfang eines Non-Boost-VR enthalten	
UST valve and accessories (129 838 01)	
UST valve and accessories (129 838 01)	
UST valve and accessories (129 838 01)	
Pre-installed tubeless rim tape	
Pre-installed tubeless rim tape	
Pre-installed tubeless rim tape	
Multifunction adjustment wrench (delivered with rear wheel) (325 423 01)	
Multifunction adjustment wrench (delivered with rear wheel) (325 423 01)	
Multifunction adjustment wrench (delivered with rear wheel) (325 423 01)	
Boost-Adapter (20x110 mm)  im Lieferumfang eines Boost-VR enthalten	
Non-Boost-Adapter (20x110 mm)  im Lieferumfang eines Non-Boost-VR enthalten	
2 replacement spokes with each wheel	
HR-Achsstummel 12x150 mm  bei HR mit 12x157-mm-Achse im Lieferumfang enthalten	
2 replacement spokes with each wheel	

COMPATIBILITY

Freewheel: Shimano HG9, XD or Micro Spline	
VR-Achse: 15x110 mm Boost (Steckachse)	
Front axle: 15x110 Boost, convertible to 20x110 Boost thru axle with adapters	
Front axle: 15x110 Boost, convertible to 20x110 Boost thru axle with adapters	
Front axle: 15x110 Boost, convertible to 20x110 Boost thru axle with adapters	
HR-Achse: 12x148 mm Boost (Steckachse)	
Freewheel: Shimano HG9, XD or Micro Spline	
Boost Axles : 15X110 ; 12X148	
Boost Axles : 15X110 ; 12X148	
Boost Axles : 15X110 ; 12X148	
DH spacing axles: 12X150 , 12x157 , 12X157-7speed	
DH spacing axles: 12X150 , 12x157 , 12X157-7speed	
DH spacing axles: 12X150 , 12x157 , 12X157-7speed	
Freewheel: Shimano HG9, XD or Micro Spline	