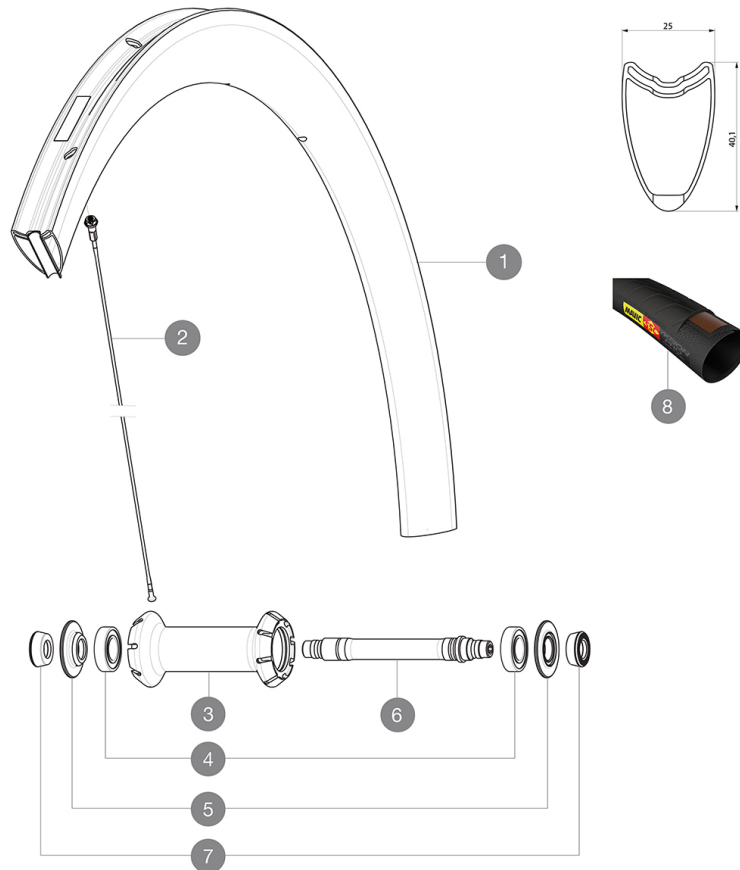

**MAVIC** *Cosmic Pro Carbon SL T*

ASTM CATEGORY 2 : road and offroad with jumps less than 15cm  
 Recommended weight limit : 120kg  
 Recommended tire sizes: 25 to 32 mm  
 Max. Pressure: 23mm 8.7 bars - 125 psi, 25/28mm 7.7 bars - 110 psi  
 Max. Pressure: 25mm 7.7 bars - 110 PSI

**REFERENCES WHEELS**

F70841 Cosmic Pro Car SL T Ft

**RIMS**

&amp;NBSP;:

1	V2406510	KIT FRONT RIM COSMIC PRO CARBON SL TUBULAR
---	----------	--

**SPOKES**

2	V3662201	KIT 12 FRT COSMIC PRO CARB SL T/C/UST & NDS CPC SL BUTTED AE
2	V2273901	KIT 9 FT BTD AERO SPK 271mm/ALU NIPPLE/WASHER - while stock

**HUB SHELLS**

3	N/A	HUB BODY
4	M40078	FRONT HUB BEARINGS 6901 x 2
5	V2252501	FRONT SETTING NUT & DUST PROTECTOR MY16
6	30870001	FRONT AXLE ROAD RIM BRAKING QRM +

**TYRES**





8	37804425	Yksion Pro GripTub SSC
---	----------	------------------------

**ADAPTERS**

7	35117301	FT/RR FORK REST R-SYS/CC ULTIMATE > 2013/KSY PRO CARB T
---	----------	---

# MAVIC Cosmic Pro Carbon SL T

## DELIVERED WITH

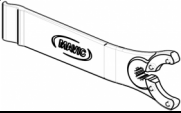
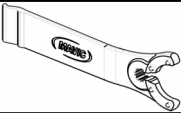
BR601 quick releases (V24 501 01 frt, V24 502 01 rear) 1	
BR601 quick releases (V24 501 01 frt, V24 502 01 rear) 1	
Carbon brake pads (V24 603 01 Shimano/Sram, V24 604 01 Campagnolo) 1 pair	
Carbon brake pads (V24 603 01 Shimano/Sram, V24 604 01 Campagnolo) 1 pair	
Multifunction adjustment wrench (325 423 01) 1	
Multifunction adjustment wrench (325 423 01) 1	
User guide	
User guide	

## COMPATIBILITY

Freewheel: Shimano/Sram or Campagnolo, convertible to XD-R with optional driver body	
Freewheel: Shimano/Sram, convertible to Campagnolo and XD-R with optional driver bodies	
Front axle: Quick Release only	
Front axle: Quick Release only	
Rear axle: Quick Release only	
Rear axle: Quick Release only	

## Specifications

### RIMS

- **Material** : 3K carbon fibers
- **Material** : 3K carbon fibers
- **Height** : 40 mm
- **Height** : 40 mm
- **Drilling** : traditional
- **Drilling** : traditional
- **Brake track** : carbon with TgMAX technology
- **Brake track** : carbon with TgMAX technology
- **Valve hole diameter** : 6.5 mm
- **Valve hole diameter** : 6.5 mm
- **Tyre** : tubular
- **ETRTO size** : 28" tubular
- **ETRTO size** : 28" tubular

### SPOKES

- **Material** : steel
- **Material** : steel
- **Shape** : straight pull, bladed, double butted
- **Shape** : straight pull, aero, double butted
- **Nipples** : aluminum, ABS
- **Nipples** : aluminum, ABS
- **Count** : front 16, rear 20
- **Count** : front 16, rear 20
- **Lacing** : front radial, rear Isopulse
- **Lacing** : front radial, rear Isopulse

### WHEEL HUB

- **Front and rear bodies** : aluminum
- **Front and rear bodies** : aluminum
- **Axle material** : aluminum
- **Axle material** : aluminum
- **Front bearings** : adjustable sealed cartridge bearings (QRM+), Rear bearings auto adjust sealed cartridge bearings (QRM Auto)
- **Front bearings** : adjustable sealed cartridge bearings (QRM+), Rear bearings auto adjust sealed cartridge bearings (QRM Auto)
- **Sealed cartridge bearings**
- **Freewheel** : Instant Drive 360
- **Freewheel** : Instant Drive 360

### VERSIONS

- **Color** : Black only
- **Color** : Black only

### WHEEL WEIGHTS

Wheel weight 620