

MAVIC *Comete Pro Carbon SL T*

ASTM CATEGORY 1 : road only

Recommended weight limit : 120kg

Recommended tire sizes: 25 to 32 mm

Max. Pressure: 23mm 8.7 bars - 125 psi, 25/28mm 7.7 bars - 110 psi

Max. Pressure: 25mm 7.7 bars - 110 PSI

REFERENCES WHEELS

R93501 Comete Pro Car SL T Rr

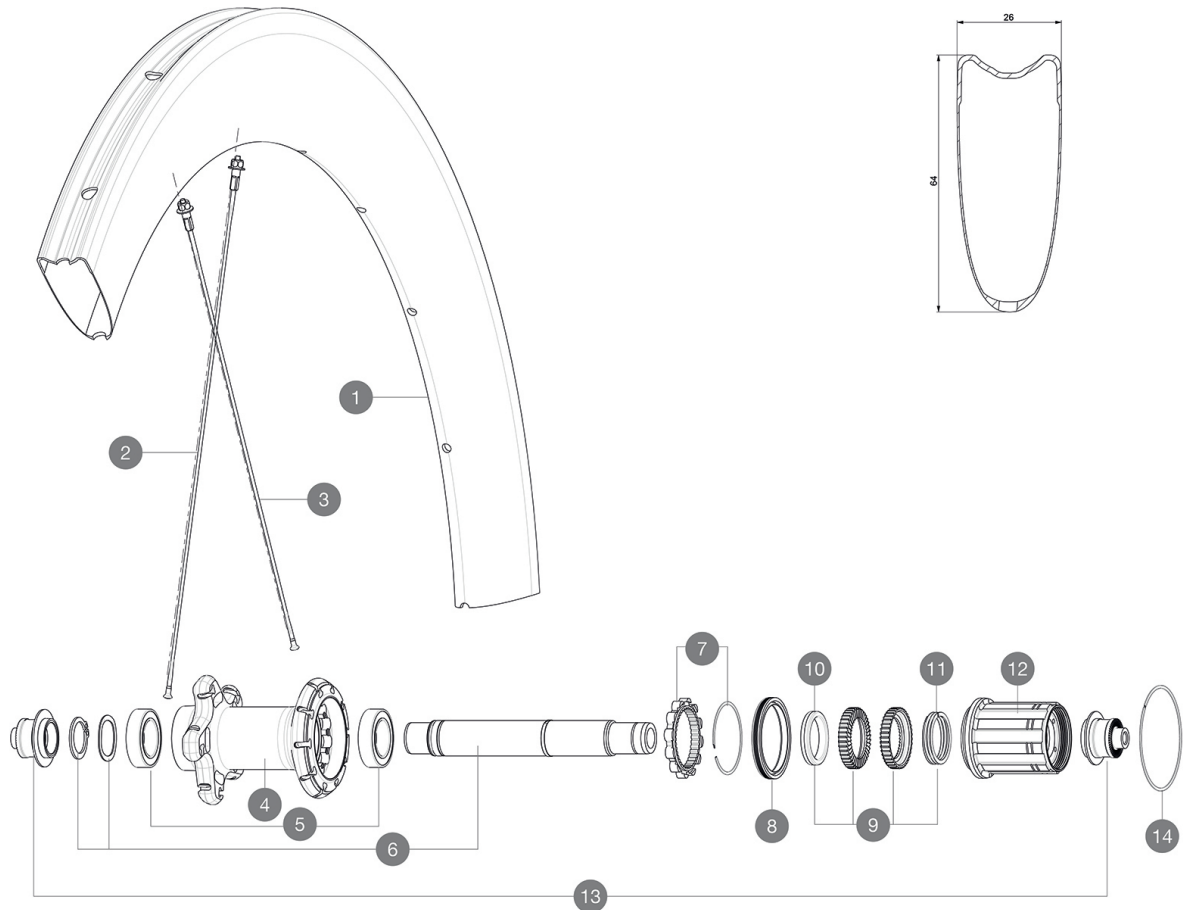
**RIMS**

&NBSP;:

1	V2731313	KIT REAR RIM COMETE PRO CARBON SL T
---	----------	-------------------------------------

SPOKES

2	V3663901	KIT 12 NON DRIVE SIDE BUTTED AERO STAINLESS SPOKE 261 + alu
2	V2278301	KIT 10 NDS BTD AERO SPOKE 261mm - while stock last
3	V2278401	KIT 10 DRIVE SIDE BUTTED AERO SPOKE 236mm
3	V3662401	KIT 12 DS BUTTED AERO STAINLESS SPOKE 236 + alu nipp.+ wash.
3	V2278501	KIT 1 FT 247/FT 253/DS 236 COMETE PRO CARB SL T D SPK

HUB SHELLS

4	N/A	HUB BODY
5	V2560401	KIT 2 BEARINGS 17x28x7 + WAVED WASHER + CLIP
6	V2252801	KIT ID360 UB REAR AXLE W/CLIP/WAVED WASHER
7	V2252701	KIT ID360 INSERT SHAPED EAR LOBE > 2017
8	V2251601	KIT ID360 SEAL + GREASE
9	V2251701	KIT ID360 2 RATCHETS + SPRING + GREASE
10	V2500501	KIT ID360 3 PADS NOISE REDUCING
11	V2251801	KIT 3 ID360 ROAD SPRINGS
12	V3430101	HG11 Freewheel Body ID360
14	V2252201	KIT 2 REAR HUB RETENTION RINGS 48mm

TYRES







15	37804425	Yksion Pro GripTub SSC
----	----------	------------------------

ADAPTERS

13	V2253101	KIT REAR AXLE ADAPTOR QUICK RELEASE ID360
----	----------	---

MAVIC Comete Pro Carbon SL T

DELIVERED WITH

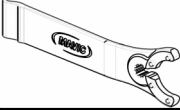
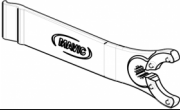
BR601 quick releases (V24 501 01 frt, V24 502 01 rear) 1	
BR601 quick releases (V24 501 01 frt, V24 502 01 rear) 1	
Carbon brake pads (V24 603 01 Shimano/Sram, V24 604 01 Campagnolo) 1 pair	
Carbon brake pads (V24 603 01 Shimano/Sram, V24 604 01 Campagnolo) 1 pair	
Valve extender (118 952 01) 1	
Valve extender (118 952 01) 1	
Multifunction adjustment wrench (325 423 01) 1	
Multifunction adjustment wrench (325 423 01) 1	
User guide	
User guide	

COMPATIBILITY

Freewheel: Shimano/Sram or Campagnolo, convertible to XD-R with optional driver body	
Front axle: Quick Release only	
Front axle: Quick Release only	
Rear axle: Quick Release only	
Rear axle: Quick Release only	

Specifications

RIMS

- Material : 3K carbon fibers
- Material : 3K carbon fibers
- Height : 64mm
- Height : 64mm
- Drilling : traditional
- Drilling : traditional
- Brake track : carbon with TgMAX technology
- Brake track : carbon with TgMAX technology
- Valve hole diameter : 6.5 mm
- Valve hole diameter : 6.5 mm
- Tire : tubular
- Tire : tubular
- ETRTO size : 28" tubular
- ETRTO size : 28" tubular

SPOKES

- Material : steel
- Material : steel
- Shape : straight pull, bladed, double butted
- Shape : straight pull, aero, double butted
- Nipples : aluminum, ABS
- Nipples : aluminum, ABS
- Count : front 18, rear 20
- Count : front 18, rear 24
- Lacing : front radial, rear Isopulse
- Lacing : front radial, rear Isopulse

WHEEL HUB

- Front and rear bodies : aluminum
- Front and rear bodies : aluminum
- Axle material : aluminum
- Axle material : aluminum
- Sealed cartridge bearings
- Front bearings : adjustable sealed cartridge bearings (QRM+), Rear bearings auto adjust sealed cartridge bearings (QRM Auto)
- Freewheel : Instant Drive 360
- Freewheel : Instant Drive 360

VERSIONS

- Color : Black only
- Color : Black only

WHEEL WEIGHTS

Wheel weight