

ASTM CATEGORY 3 : offroad with jumps less than 61cm
Recommended weight limit : 120kg
Recommended tire sizes: 28 mm to 62 mm (1.1" to 2.5")

REFERENCES WHEELS

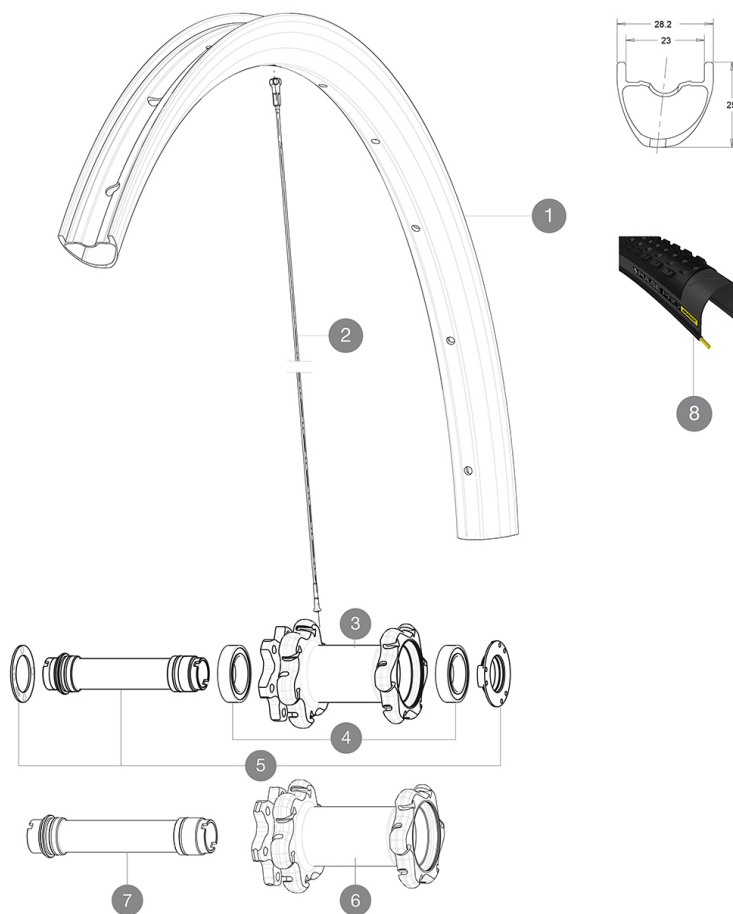

RIMS



VALVE HOLE (MM): 6,5 :

| | | |
|---|----------|--|
| 1 | V3100110 | KIT FRONT RIM CROSSMAX PRO CARBON 29" |
| | V2620101 | UST RIM TAPE 25mm (for 21-24mm wide rim) |

SPOKES

| | | |
|---|----------|---|
| 2 | V2384601 | KIT 12 FT/ND5 CROSSMAX PRO CARB 29" SPK 292mm |
|---|----------|---|

HUB SHELLS

| | | |
|---|----------|---|
| 3 | N/A | HUB BODY |
| 4 | 99688501 | BEARING KIT 9/12/15 D6T HUB 20x32x7 6804 |
| 5 | V2252301 | KIT MY16 FRONT AXLE ROAD DISC 9/12/15 INT |
| 6 | N/A | HUB BODY |
| 7 | V2370701 | KIT FRONT QRM+ AXLE BOOST INTL 110mm |

OPTIONS

| | |
|----------|--|
| V2650201 | ADAPTER Front Torque Cap 15x31 MTB QRM + |
|----------|--|

TYRES







| | | |
|---|----------|--------------|
| 8 | 39243232 | Pulse Pro 29 |
| 8 | 39243221 | Pulse Pro 29 |

ADAPTERS

| | |
|----------|------------------------|
| B4104301 | ADAPTER Ft 9mm QR QRM+ |
|----------|------------------------|

MAVIC Crossmax Pro Carbon 29

DELIVERED WITH

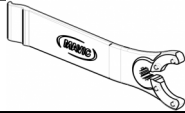
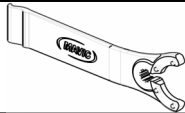
| | |
|---|---|
| 1 bottle of Mavic Sealant (355 466 01) 1 |  |
| BX601 quick releases (V24 503 01 frt, V24 504 01 rear) 1 |  |
| Front QR adapters (996 941 01 for MTB or B41 043 01 for road) 1 |  |
| Rear 12x142mm adapters for ITS4 and TS2 (308 593 01 for ITS4, 329 650 01 for TS2) 1 |  |
| UST valve and accessories (129 838 01) |  |
| UST valve and accessories (129 838 01) |  |
| Specific disc bolts (308 719 01) Pack of 6 |  |
| Tubeless rim tape | |
| Tubeless rim tape | |
| Multifunction adjustment wrench (325 423 01) 1 |  |
| Multifunction adjustment wrench (325 423 01) 1 |  |
| User guide | |
| User guide | |

COMPATIBILITY

| | |
|---|--|
| Freewheel: Shimano/Sram, convertible to XD with optional driver body | |
| Freewheel: Shimano/Sram or XD | |
| Front axle: convertible from 15mm thru axle to Quick Release with included adapters | |
| Front axle: convertible from 15mm thru axle to Quick Release with included adapters | |
| Rear axle: 12mm thru axle, convertible to Quick Release with optional adapters | |

Specifications

RIMS

- **Material** : 100% Unidirectional carbon fiber
- **Material** : 100% Unidirectional carbon fiber
- **Joint** : SUP
- **Drilling** : traditional
- **Drilling** : traditional
- **Valve hole diameter** : 6.5 mm
- **Valve hole diameter** : 6.5 mm
- **Tire** : UST Tubeless and tubetype
- **Tire** : UST Tubeless and tubetype
- **Internal width** : 23 mm
- **Internal width** : 23 mm
- **ETRTO size 27.5"** : 584x23ss
- **ETRTO size 27.5"** : 584x23ss
- **ETRTO size 29"** : 622x23ss
- **ETRTO size 29"** : 622x23ss

Hookless profile

Hookless profile

Use with Mavic Tubeless Tape date: 2022-05-31

Use with Mavic Tubeless Tape

WHEEL HUB

- **Front and rear bodies** : aluminum
- **Front and rear bodies** : aluminum
- **Axle material** : aluminum
- **Axle material** : aluminum
- Adjustable sealed cartridge bearings
- Adjustable sealed cartridge bearings
- **Freewheel** : ITS-4 alloy
- **Freewheel** : ITS-4 alloy

VERSIONS

- **Color** : Black only
- **Color** : Black only
- **Disc standard** : 6 Bolts only
- **Disc standard** : 6 Bolts only
- **Hub width** : Boost (front 110, rear 148) or Non-Boost (front 100, rear 135/142)
- **Hub width** : Boost (front 110, rear 148) or Non-Boost (front 100, rear 135/142)
- Lefty Supermax
- Lefty Supermax

WHEEL WEIGHTS

Wheel weight
Weight Front 27.5": 680
Weight Front 29": 700