

ASTM CATEGORY 2 : road and offroad with jumps less than 15cm
 For a longer longevity of the wheel, Mavic recommends that the total weight supported by the wheels doesn't exceed 120kg, bike included
 Recommended tire sizes: 25 to 32 mm
 Max. Pressure: see indication on wheel and tire. If they differ, use the lowest of the 2

RÉFÉRENCES ROUES

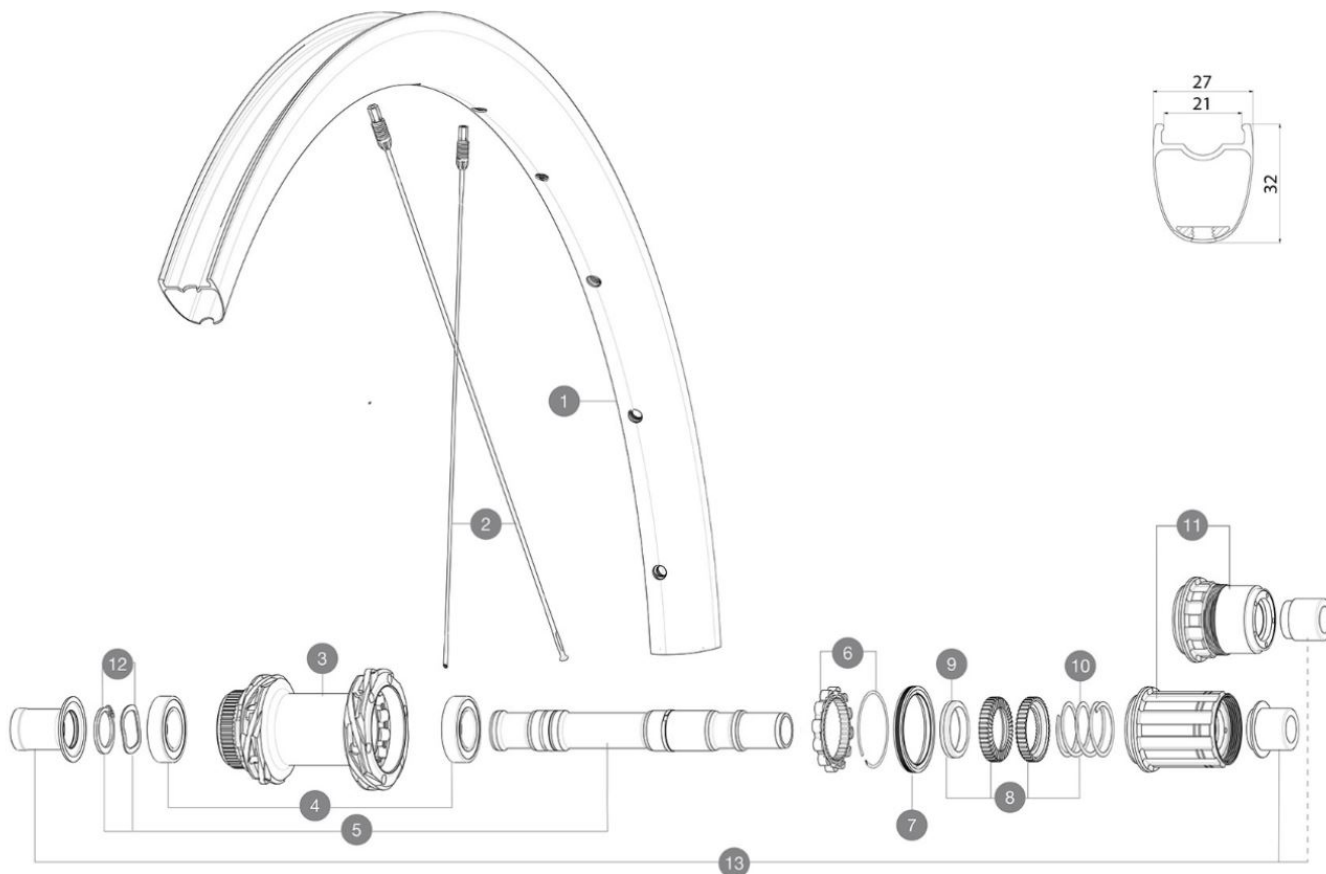

JANTES



&NBSP;:

1 V00063431 Kit Front/Rear rim Cosmic SLR32 Ltd

RAYONS

2 V4164801 Kit 12 CosmicSLR32 Disc aero sspk M6 291

MOYEURS

3	N/A	CORPS DE MOYEU
3	N/A	CORPS DE MOYEU
4	M40076	HUB BEARINGS 17x30x7 6903 x 2
5	V00046431	KIT AXE ID360 142LIGHT CL+CIR
6	V2252701	KIT ID360 INSERT SHAPED EAR LOBE > 2017
7	V00063631	Kit ID360 seal version 2 (larger)
8	V2251701	ID360 2 RATCHETS + SPRING + GREASE
9	V2500501	Kit 3 ID360 pad for noise reduction
10	V2251801	KIT 3 ID360 ROAD SPRINGS
11	V3430101	HG11 Freewheel Body ID360
11	V2580101	FREEHUB BODY XD Road ID360
12	V2373001	KIT ADJUST. SYSTEM QRM AUTO ID360 for 17x30x7 bearing

OPTIONS

V2373401 KIT ID360 135/142 DCL L1 AXLE WITH CLIP

ADAPTATEURS

13	V3811001	KIT ROAD ID360 RR CL ENDCAP (12MM)
	V2510801	ID360 EVO REAR AXLE ADAPTERS 9x135mm DCL & D6T
	V2510901	ID360 EVO REAR AXLE ADAPTERS 12x135mm DCL & D6T

MAVIC **COSMIC SLR 32 LTD****LIVRE AVEC**

UST valve and accessories (129 838 01)	
User guide	

COMPATIBILITE

Freewheel: Shimano/Sram, convertible to Campagnolo ED11, N3W and XD-R with optional driver bodies	
Rear axle: 12mm thru axle, convertible to Quick Release with optional adapters and axle replacement	
Front axle: 12x100 thru axle, easily convertible to quick release with optional adapters. Not compatible with 15mm through axles	

Spécifications**JANTES**

- **Material** : 100% carbon fiber with UD² external layer
 - **Material** : 100% carbon fiber
 - **Height** : 32mm
- Disc brake specific profile
- **Tire** : UST Tubeless and tubetype
 - **Internal width** : 21 mm
 - **ETRTO size** : 622x21TC
- Fore Carbon tapeless tubeless technology
UST tubeless technology

RAYONS

- **Material** : steel
- **Shape** : straight pull, elliptical aero, double butted (patented)
- **Nipples** : Fore integrated aluminum
- **Count** : 24 front and rear
- **Lacing** : front and rear crossed 2, contactless

MOYEUX

- **Front and rear bodies** : aluminum
 - **Axle material** : aluminum
 - **Front** : Quick release and 12x100 through axle compatible
 - **Rear** : Quick Release, 12x142 and 12x135 compatible
- Infinity hubs
Moyeu disponible avec disque de frein Center Lock uniquement
Instant Drive 360 freewheel technology
QRM Auto bearing preload technology

VERSIONS

- **Disc standard** : Center Lock[®] only
- **Freewheel** : Shimano/Sram

POIDS ROUES

760