

ASTM CATEGORIA 3 : fuoristrada con salti fino a 61 cm
Per una maggiore durata della ruota, Mavic raccomanda di non superare il peso massimo di 120 kg supportato dalle ruote, bicicletta compresa
Dimensione pneumatico consigliata: da 35 mm a 69 mm (da 1,4" a 2,7")
Dimensione pneumatico consigliata: da 46 mm a 64 mm (da 1,8" a 2,5")

REFERENZE RUOTE

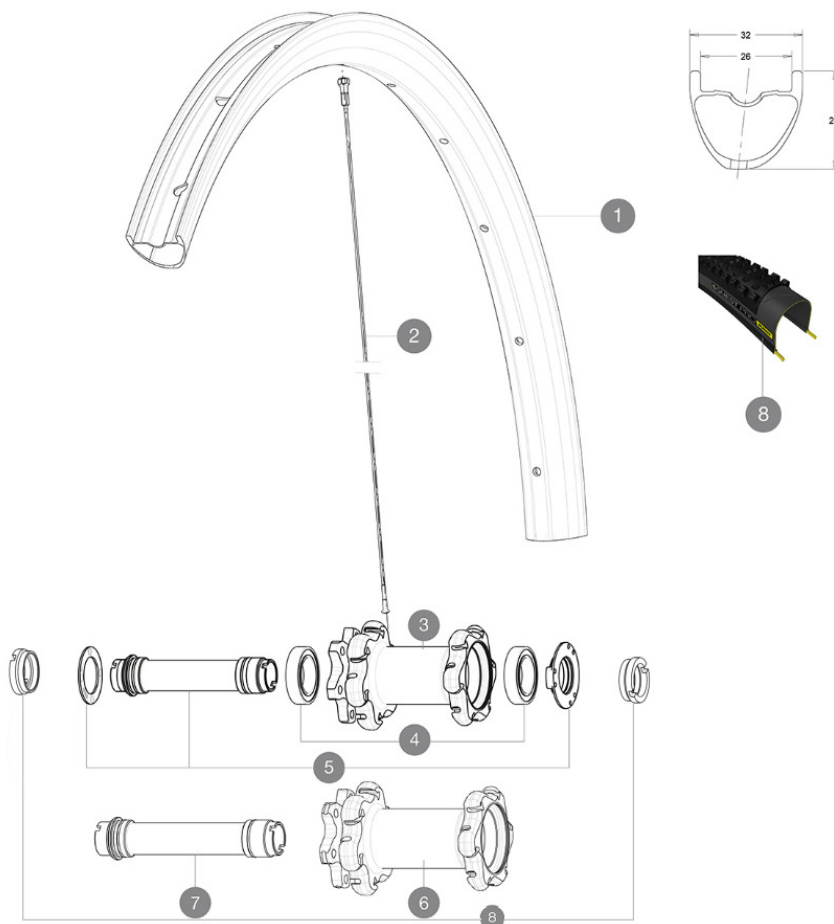

RIMS



FORO VALVOLA (MM): 6,5 :

| | | |
|---|----------|--|
| 1 | V3040110 | KIT FRONT RIM XA PRO CARBON 27,5" |
| | V2700101 | UST Tape 28mm for 25 to 27mm wide rims |

SPOKES

| | | |
|---|----------|--|
| 2 | V2385001 | KIT 12 FRONT + REAR NON-DRIVE SIDE BUTTED SPOKES 272mm XA PR |
|---|----------|--|

HUB SHELLS

| | | |
|---|----------|---------------------------------------|
| 3 | N/A | CORPO MOZZO |
| 4 | 99688501 | BEARING KIT 9/15 D6T HUB |
| 5 | V2252301 | MY16 FRONT AXLE ROAD DISC 9/12/15 INT |
| 6 | N/A | CORPO MOZZO |
| 7 | V2370701 | KIT FRONT QRM+ AXLE BOOST INTL 110mm |

OPTIONS

| | |
|----------|--|
| V2650201 | ADAPTER Front Torque Cap 15x31 MTB QRM + |
|----------|--|

TYRES









| | | |
|---|----------|---------------------|
| 8 | 39243324 | Quest Pro 27,5x2.40 |
|---|----------|---------------------|

ADAPTERS

| | | |
|---|----------|-------------------------------|
| 8 | B4104401 | 15mm FT Road Axle Adapters 16 |
| | B4104301 | 9mm FT road Axle Adapters 16 |

MAVIC XA Pro Carbon

VENUTO CON

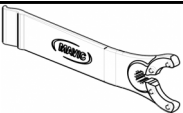
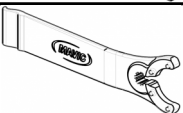
| | |
|--|---|
| 1 flacone di sigillante Mavic (355 466 01) 1 |  |
| Bloccaggi rapidi BX601 (anteriore V24 503 01, posteriore V24 504 01) 1 |  |
| Bloccaggi rapidi BX601 (anteriore V24 503 01, posteriore V24 504 01) 1 |  |
| Adattatori bloccaggio rapido anteriore (996 941 01 per MTB o B41 043 01 per strada) 1 |  |
| Adattatori bloccaggio rapido anteriore (996 941 01 per MTB o B41 043 01 per strada) 1 |  |
| Adattatori posteriori bloccaggio rapido per ITS4 e TS2 (308 731 01) | |
| Adattatori posteriori 12x142 mm per ITS4 e TS2 (308 593 01 per ITS4, 329 650 01 per TS2) 1 |  |
| Adattatori posteriori 12x142 mm per ITS4 e TS2 (308 593 01 per ITS4, 329 650 01 per TS2) 1 |  |
| Valvola e accessori UST (129 838 01) |  |
| Valvola e accessori UST (129 838 01) |  |
| Flap tubeless | |
| Flap tubeless | |
| Chiave di regolazione multifunzione (325 423 01) 1 |  |
| Chiave di regolazione multifunzione (325 423 01) 1 |  |
| Guida utente | |
| Guida utente | |

COMPATIBILITY

| | |
|--|--|
| Freewheel: Shimano/Sram or XD | |
| Ruota libera: Shimano/Sram, convertibile in XD con corpo trasmissione opzionale | |
| Perno anteriore: convertibile da perno passante da 15 mm in bloccaggio rapido con adattatori inclusi | |
| Perno anteriore: convertibile da perno passante da 15 mm in bloccaggio rapido con adattatori inclusi | |
| Rear axle: 12mm thru axle, convertible to Quick Release with included adapters | |
| Perno posteriore: perno passante da 12mm convertibile a bloccaggio rapido con adattatori opzionali (non disponibile in Germania) | |

Specifications

CERCHIONI

- Materiale : 100% fibra di carbonio unidirezionale
- Materiale : 100% fibra di carbonio unidirezionale
- Foratura : tradizionale
- Foratura : tradizionale
- Diametro foro valvola : 6,5 mm

MOZZO

- Corpo anteriore e posteriore : alluminio
- Corpo anteriore e posteriore : alluminio
- Materiale perno : alluminio
- Materiale perno : alluminio
- Cuscinetti a cartuccia sigillati regolabili

PESI RUOTE

- Peso della ruota
- Weight Front 27.5": 715
- Weight Front 29": 735