

ASTM CATEGORIA 3 : fuoristrada con salti fino a 61 cm

Per una maggiore durata della ruota, Mavic raccomanda di non superare il peso massimo di 120 kg supportato dalle ruote, bicicletta compresa

Dimensione pneumatico consigliata: da 35 mm a 69 mm (da 1,4" a 2,7")

Dimensione pneumatico consigliata: da 46 mm a 64 mm (da 1,8" a 2,5")

REFERENZE RUOTE

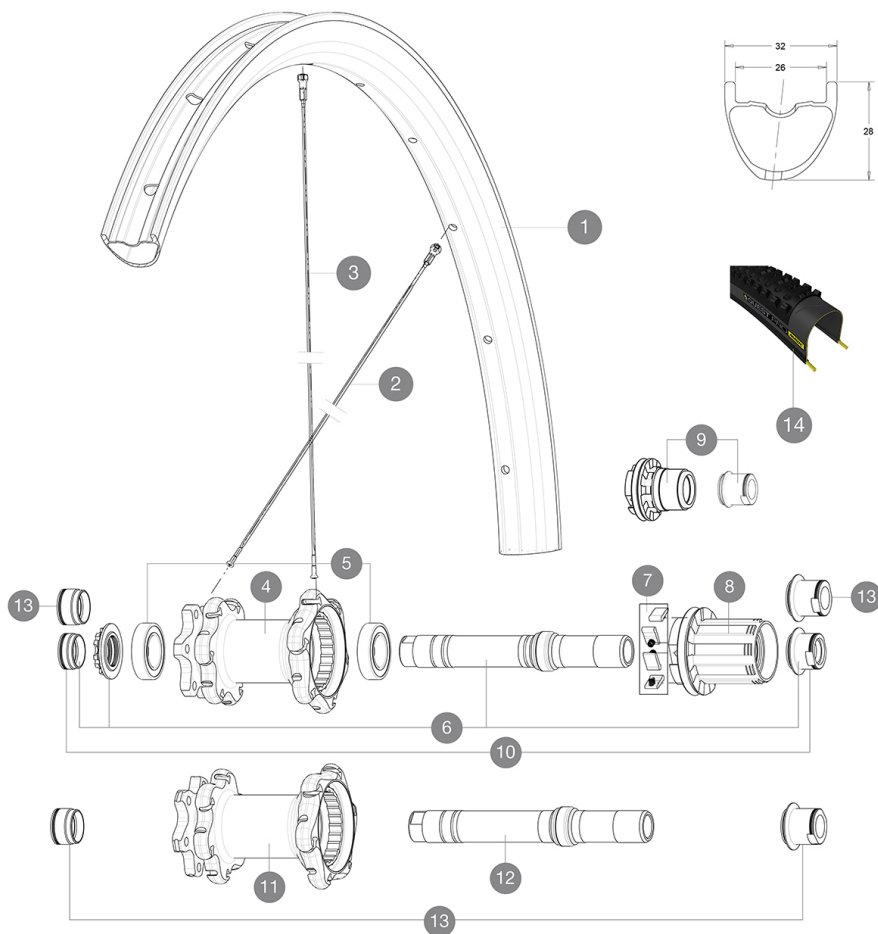

RIMS



FORO VALVOLA (MM): 6,5 :

1	V3050113	KIT REAR RIM XA PRO CARBON 27,5"
	V2700101	UST Tape 28mm for 25 to 27mm wide rims

SPOKES

2	V2385001	KIT 12 FRONT + REAR NON-DRIVE SIDE BUTTED SPOKES 272mm XA PR
3	V2384901	KIT 12 REAR DRIVE SIDE BUTTED SPOKES 270mm XA PRO CARBON 27,

HUB SHELLS

4	N/A	CORPO MOZZO
5	M40076	HUB BEARINGS 17x30x7 6903 x 2
6	30870401	REAR AXLE KIT ITS4 135mm D6T/DCL 2012
7	99610601	ITS4 PAWLS KIT
8	35126001	ITS-4 FREEWHEEL BODY + SEAL 2013 (WITHOUT PAWLS)
8	99610701	ITS4 SEAL
9	35684101	ITS-4 FREEWHEEL BODY XD +SEAL 2013 (WITHOUT PAWLS)
11	N/A	CORPO MOZZO
12	V2370801	KIT REAR QRM+ AXLE BOOST ITS-4 148mm

TYRES









14	39243324	Quest Pro 27,5x2.40
----	----------	---------------------

ADAPTERS

10	30872201	FORK REST ITS-4 135mm REAR AXLE > 2012
13	30859301	AXLE ADAPTER Rr 12x142/148mm Pro Carb MTB (Grey)
	30873101	2 REAR REDUCERS 12/9,5mm 2012 ITS4 HUB

MAVIC XA Pro Carbon

VENDUTO CON

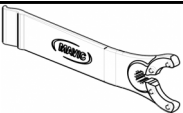
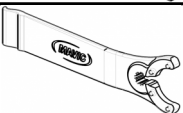
1 flacone di sigillante Mavic (355 466 01) 1	
Bloccaggi rapidi BX601 (anteriore V24 503 01, posteriore V24 504 01) 1	
Bloccaggi rapidi BX601 (anteriore V24 503 01, posteriore V24 504 01) 1	
Adattatori bloccaggio rapido anteriore (996 941 01 per MTB o B41 043 01 per strada) 1	
Adattatori bloccaggio rapido anteriore (996 941 01 per MTB o B41 043 01 per strada) 1	
Adattatori posteriori bloccaggio rapido per ITS4 e TS2 (308 731 01)	
Adattatori posteriori 12x142 mm per ITS4 e TS2 (308 593 01 per ITS4, 329 650 01 per TS2) 1	
Adattatori posteriori 12x142 mm per ITS4 e TS2 (308 593 01 per ITS4, 329 650 01 per TS2) 1	
Valvola e accessori UST (129 838 01)	
Valvola e accessori UST (129 838 01)	
Flap tubeless	
Flap tubeless	
Chiave di regolazione multifunzione (325 423 01) 1	
Chiave di regolazione multifunzione (325 423 01) 1	
Guida utente	
Guida utente	

COMPATIBILITY

Freewheel: Shimano/Sram or XD	
Ruota libera: Shimano/Sram, convertibile in XD con corpo trasmissione opzionale	
Perno anteriore: convertibile da perno passante da 15 mm in bloccaggio rapido con adattatori inclusi	
Perno anteriore: convertibile da perno passante da 15 mm in bloccaggio rapido con adattatori inclusi	
Rear axle: 12mm thru axle, convertible to Quick Release with included adapters	
Perno posteriore: perno passante da 12mm convertibile a bloccaggio rapido con adattatori opzionali (non disponibile in Germania)	

Specifications

CERCHIONI

- **Materiale** : 100% fibra di carbonio unidirezionale
- **Materiale** : 100% fibra di carbonio unidirezionale
- **Foratura** : tradizionale
- **Foratura** : tradizionale
- **Diametro foro valvola** : 6,5 mm

MOZZO

- **Corpo anteriore e posteriore** : alluminio
- **Corpo anteriore e posteriore** : alluminio
- **Materiale perno** : alluminio
- **Materiale perno** : alluminio
- **Cuscinetti** a cartuccia sigillati regolabili

PESI RUOTE

- Peso della ruota
- Weight Rear 27.5": 835
- Weight Rear 29": 855