

ASTM CATEGORY 3 : offroad with jumps less than 61cm
 Recommended weight limit : 120kg
 Recommended tire sizes: 35 mm to 69 mm (1.4" to 2.7")
 Recommended tyre sizes: 46mm to 64mm (1.8" to 2.5")

REFERENCES WHEELS

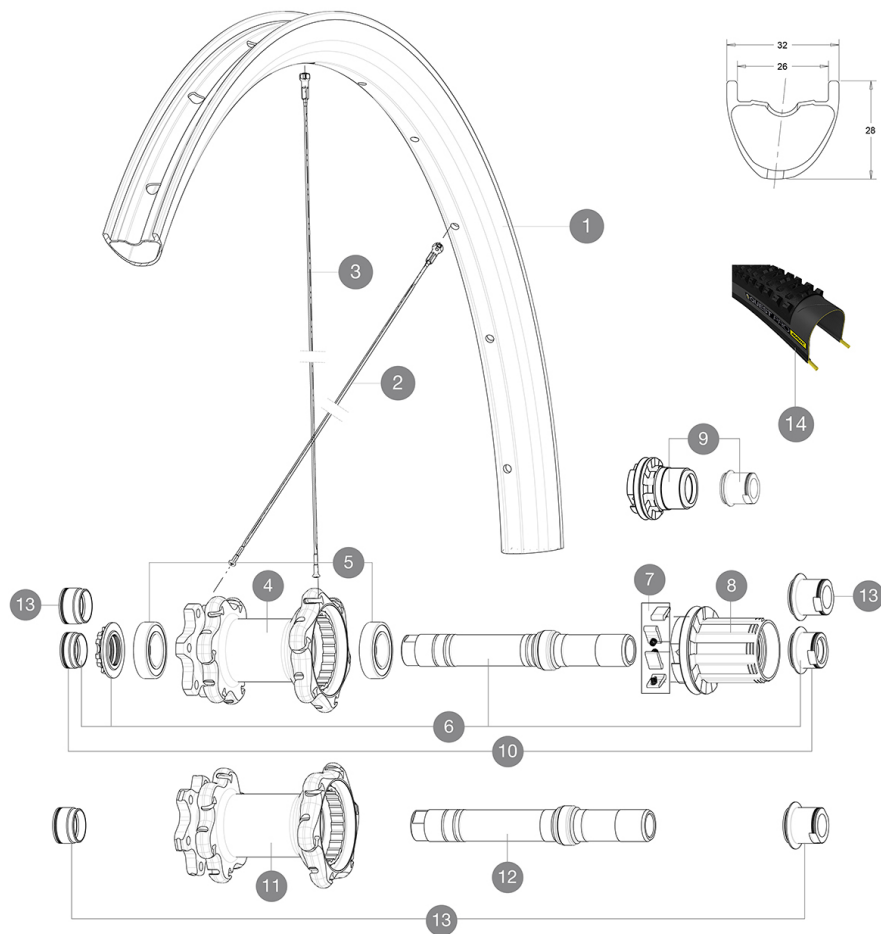

RIMS



VALVE HOLE (MM): 6,5 :

1	V3050113	KIT REAR RIM XA PRO CARBON 27,5"
	V2700101	UST Tape 28mm for 25 to 27mm wide rims

SPOKES

2	V2385001	KIT 12 FT/NDS XA PRO CARBON 27,5" SPK 270mm
3	V2384901	KIT 12 DS XA PRO CARBON 27,5" SPK 268mm

HUB SHELLS

4	N/A	HUB BODY
5	M40076	HUB BEARINGS 17x30x7 6903 x 2
6	30870401	REAR QRM + AXLE KIT ITS4 135mm from 2012
7	99610601	PAWLS KIT FOR ITS-4 (OR TS-2)
8	35126001	ITS-4 FREEWHEEL BODY + SEAL 2013 (NO PAWLS)
8	99610701	ITS-4 FREEWHEEL SEAL
9	35684101	FREEHUB BODY XD TS2/ITS-4
11	N/A	HUB BODY
12	V2370801	KIT REAR QRM+ AXLE BOOST ITS-4 148mm

TYRES









14	39243324	Quest Pro 27.5
----	----------	----------------

ADAPTERS

10	30872201	FRAME SUPPORT ITS-4 135mm REAR AXLE > 2012
13	30859301	AXLE ADAPTER Rr 12x142/148mm Pro Carb MTB (Grey)
	30873101	2 REAR REDUCERS 12/9,5mm 2012 ITS4 HUB

MAVIC XA Pro Carbon

DELIVERED WITH

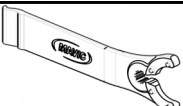
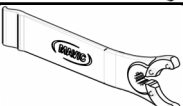
1 bottle of Mavic Sealant (355 466 01) 1	
BX601 quick releases (V24 503 01 frt, V24 504 01 rear) 1	
BX601 quick releases (V24 503 01 frt, V24 504 01 rear) 1	
Front QR adapters (996 941 01 for MTB or B41 043 01 for road) 1	
Front QR adapters (996 941 01 for MTB or B41 043 01 for road) 1	
Rear QR adapters for ITS4 and TS2 (308 731 01)	
Rear 12x142mm adapters for ITS4 and TS2 (308 593 01 for ITS4, 329 650 01 for TS2) 1	
Rear 12x142mm adapters for ITS4 and TS2 (308 593 01 for ITS4, 329 650 01 for TS2) 1	
UST valve and accessories (129 838 01)	
UST valve and accessories (129 838 01)	
Tubeless rim tape	
Tubeless rim tape	
Multifunction adjustment wrench (325 423 01) 1	
Multifunction adjustment wrench (325 423 01) 1	
User guide	
User guide	

COMPATIBILITY

Freewheel: Shimano/Sram, convertible to XD with optional driver body	
Freewheel: Shimano/Sram or XD	
Front axle: convertible from 15mm thru axle to Quick Release with included adapters	
Front axle: convertible from 15mm thru axle to Quick Release with included adapters	
Rear axle: 12mm thru axle, convertible to Quick Release with optional adapters	
Rear axle: 12mm thru axle, convertible to Quick Release with included adapters	

Specifications

RIMS

- **Material** : 100% Unidirectional carbon fiber
- **Material** : 100% Unidirectional carbon fiber
- **Drilling** : traditional
- **Drilling** : traditional
- **Valve hole diameter** : 6.5 mm

WHEEL HUB

- **Front and rear bodies** : aluminum
 - **Front and rear bodies** : aluminum
 - **Axle material** : aluminum
 - **Axle material** : aluminum
- Adjustable sealed cartridge bearings

WHEEL WEIGHTS

- Wheel weight
- Weight Rear 27.5": 835
- Weight Rear 29": 855