

参照ホイール

ASTM CATEGORY 3 : offroad with jumps less than 61cm
 For a longer longevity of the wheel, Mavic recommends that the total weight supported by the wheels don't exceed 120kg, bike included
 Recommended tyre sizes: 28 mm to 62 mm (1.1" to 2.5")

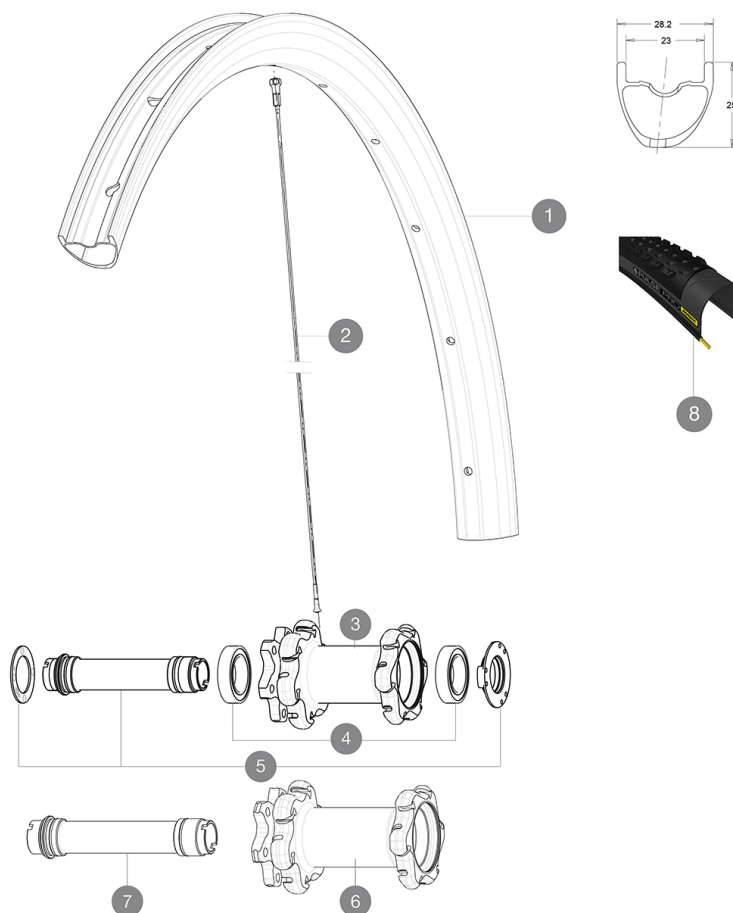

RIMS



Á□□Á□«Á□□Ç©'Á%□í%□MMí%□í%□6,5 :

1	V3100110	KIT FRONT RIM CROSSMAX PRO CARBON 29"
	V2620101	UST RIM TAPE 25mm (for 21-24mm wide rim)

SPOKES

2	V2384601	KIT 12 FRONT + REAR NON-DRIVE SIDE BUTTED SPOKES 292mm CROSS
---	----------	--------------------------------------------------------------

HUB SHELLS

3	N/A	HUB BODY
4	99688501	BEARING KIT 9/15 D6T HUB
5	V2252301	MY16 FRONT AXLE ROAD DISC 9/12/15 INT
6	N/A	HUB BODY
7	V2370701	KIT FRONT QRM+ AXLE BOOST INTL 110mm

OPTIONS

V2650201	ADAPTER Front Torque Cap 15x31 MTB QRM +
----------	------------------------------------------

TYRES

8	39243232	Pulse Pro 29" 2.25
8	39243221	Pulse Pro 29" 2.1







ADAPTERS

B4104301	9mm FT road Axle Adapters 16
----------	------------------------------

MAVIC

Crossmax Pro Carbon 29

付属品

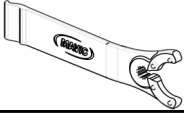
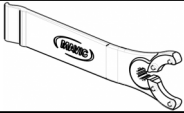
1 bottle of Mavic Sealant (355 466 01) 1	
BX601 quick releases (V24 503 01 frt, V24 504 01 rear) 1	
Front QR adapters (996 941 01 for MTB or B41 043 01 for road) 1	
Rear 12x142mm adapters for ITS4 and TS2 (308 593 01 for ITS4, 329 650 01 for TS2) 1	
UST valve and accessories (129 838 01)	
UST valve and accessories (129 838 01)	
Specific disc bolts (308 719 01) Pack of 6	
Tubeless rim tape	
Tubeless rim tape	
Multifunction adjustment wrench (325 423 01) 1	
Multifunction adjustment wrench (325 423 01) 1	
User guide	
User guide	

COMPATIBILITY

Freewheel: Shimano/Sram or XD	
Freewheel: Shimano/Sram, convertible to XD with optional driver body	
Front axle: convertible from 15mm thru axle to Quick Release with included adapters	
Front axle: convertible from 15mm thru axle to Quick Release with included adapters	
Rear axle: 12mm thru axle, convertible to Quick Release with optional adapters	

Specifications

リム

- Material : 100% Unidirectional carbon fiber
- Material : 100% Unidirectional carbon fiber
- Ä¿Ä¿Ä¿Ä¿Ä¿ : SUP
- Drilling : traditional
- Drilling : traditional
- Valve hole diameter : 6.5 mm
- Valve hole diameter : 6.5 mm
- Tyre : UST Tubeless and tubetype
- Tyre : UST Tubeless and tubetype
- Internal width : 23 mm
- Internal width : 23 mm
- ETRTO size 27.5" : 584x23ss
- ETRTO size 27.5" : 584x23ss
- ETRTO size 29" : 622x23ss
- ETRTO size 29" : 622x23ss

スポーク

- Material : steel

ホイールハブ

- Front and rear bodies : aluminum
- Front and rear bodies : aluminum
- Axle material : aluminum
- Axle material : aluminum
- Adjustable sealed cartridge bearings
- Adjustable sealed cartridge bearings
- Freewheel : ITS-4 alloy
- Freewheel : ITS-4 alloy

VERSIONS

- Color : Black only
- Color : Black only
- Disc standard : 6 Bolts only
- Disc standard : 6 Bolts only
- Hub width : Boost (front 110, rear 148) or Non-Boost (front 100, rear 135/142)
- Hub width : Boost (front 110, rear 148) or Non-Boost (front 100, rear 135/142)
- Lefty Supermax
- Lefty Supermax

ホイールの重み

- ホイール重量 (クイックリリースおよびクリンチャー/チューブラーを除く) (g) :
- Weight Front 27.5": 680
- Weight Front 29": 700