

ASTM CATEGORY 3 : offroad with jumps less than 61cm
 For a longer longevity of the wheel, Mavic recommends that the total weight supported by the wheels don't exceed 120kg, bike included
 Recommended tyre sizes: 28 mm to 62 mm (1.1" to 2.5")
 Recommended tyre sizes: 36 mm to 64 mm (1.4" to 2.5")

参照ホイール

F54801 XmxPro27.5Ft

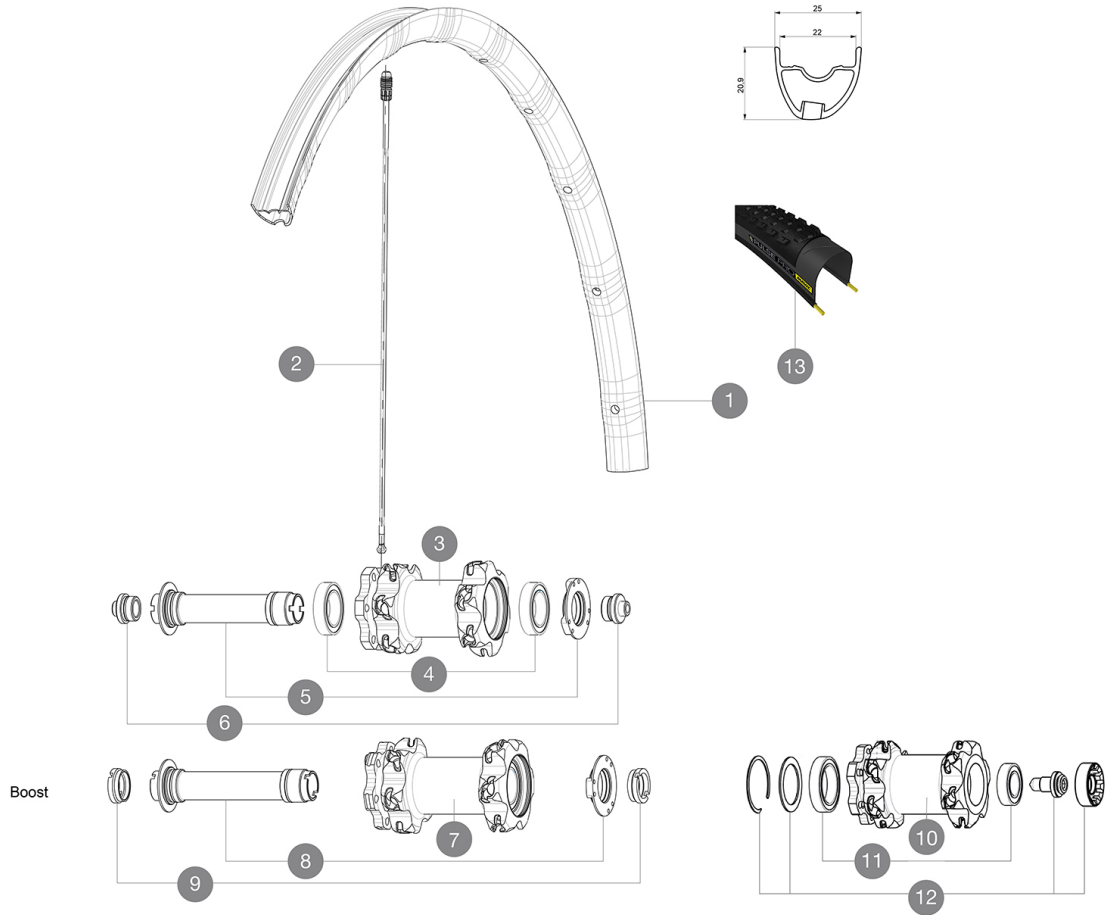

RIMS



ÄÖÅ«ÄÖÇ®'À%ÖÏ¼MMÏ¼ÖÏ¼6,5 :

1	V2316010	KIT FRONT RIM CROSSMAX PRO 27,5" 22TSS
---	----------	--

SPOKES

2	V2386401	KIT 1 275mm 27,5" + 1 293mm 29" CROSSMAX PRO STAMPED
2	V2384701	RIGHT FRONT + 1 REAR NON-DRIVE SIDE BUTTED ZICRAL SPOKES 2

HUB SHELLS

3	N/A	HUB BODY
4	99688501	BEARING KIT 9/15 D6T HUB
5	V2252301	MY16 FRONT AXLE ROAD DISC 9/12/15 INT
7	N/A	HUB BODY
8	V2370701	KIT FRONT QRM+ AXLE BOOST INTL 110mm
10	N/A	HUB BODY
11	M40771	BEARING KIT FOR LEFTY HUB
12	36709301	ASSEMBLY KIT CROSSROC SUPERMAX

OPTIONS

V2650201	ADAPTER Front Torque Cap 15x31 MTB QRM +
----------	--

TYRES

13	39243132	Pulse Pro 27,5" 2.25
13	39243121	Pulse Pro 27,5" 2.1









ADAPTERS

6	B4104301	9mm FT road Axle Adapters 16
9	B4104401	15mm FT Road Axle Adapters 16

MAVIC

Crossmax Pro

付属品

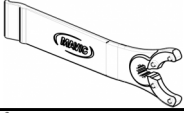
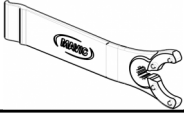
1 bottle of Mavic Sealant (355 466 01) 1	
BX601 quick releases (V24 503 01 frt, V24 504 01 rear) 1	
BX601 quick releases (V24 503 01 frt, V24 504 01 rear) 1	
Front QR adapters (996 941 01 for MTB or B41 043 01 for road) 1	
Front QR adapters (996 941 01 for MTB or B41 043 01 for road) 1	
ITS4 TS2 QRA (308 731 01)	
Rear 12x142mm adapters for ITS4 and TS2 (308 593 01 for ITS4, 329 650 01 for TS2) 1	
Rear 12x142mm adapters for ITS4 and TS2 (308 593 01 for ITS4, 329 650 01 for TS2) 1	
UST valve and accessories (129 838 01)	
UST valve and accessories (129 838 01)	
Multifunction adjustment wrench (325 423 01) 1	
Multifunction adjustment wrench (325 423 01) 1	
User guide	
User guide	

COMPATIBILITY

Freewheel: Shimano/Sram, convertible to XD with optional driver body	
Freewheel: Shimano/Sram or XD	
Front axle: convertible from 15mm thru axle to Quick Release with included adapters	
Front axle: convertible from 15mm thru axle to Quick Release with included adapters	
Rear axle: 12mm thru axle, convertible to Quick Release with optional adapters	
Rear axle: 12mm thru axle, convertible to Quick Release with included adapters	

Specifications

リム

- Material : Mxaltal
- Material : Mxaltal
- Joint : SUP
- Joint : SUP
- Drilling : Fore
- Drilling : Fore
- Weight reduction : ISM 4D
- Weight reduction : ISM 4D
- Valve hole diameter : 6.5 mm
- Valve hole diameter : 6.5 mm
- Tyre : UST Tubeless and tubetype
- Tyre : UST Tubeless and tubetype
- Internal width : 22 mm
- Internal width : 22 mm
- ETRTO size 27.5" : 584x22ss
- ETRTO size 27.5" : 584x22ss

ホイールハブ

- Front and rear bodies : aluminum
- Front and rear bodies : aluminum
- Axle material : aluminum
- Axle material : aluminum
- Sealed cartridge bearings
- Sealed cartridge bearings
- Freewheel : ITS-4 alloy
- Freewheel : ITS-4 alloy

VERSIONS

- Color : Black only
- Color : Black only
- Disc standard : 6 Bolts only
- Disc standard : 6 Bolts only
- Hub width : Boost (front 110, rear 148) or Non-Boost (front 100, rear 135/142)

ホイールの重み

- ホイール重量 (クイックリリースおよびクリンチャー/チューブラーを除く) (g) :
- Weight Front 27.5": 700
- Weight Front 29": 730