

参照ホイール

ASTM CATEGORY 3 : offroad with jumps less than 61cm
For a longer longevity of the wheel, Mavic recommends that the total weight supported by the wheels don't exceed 120kg, bike included
Recommended tyre sizes: 35 mm to 69 mm (1.4" to 2.7")
Recommended tyre sizes: 46 to 64 mm (1.8" to 2.5")

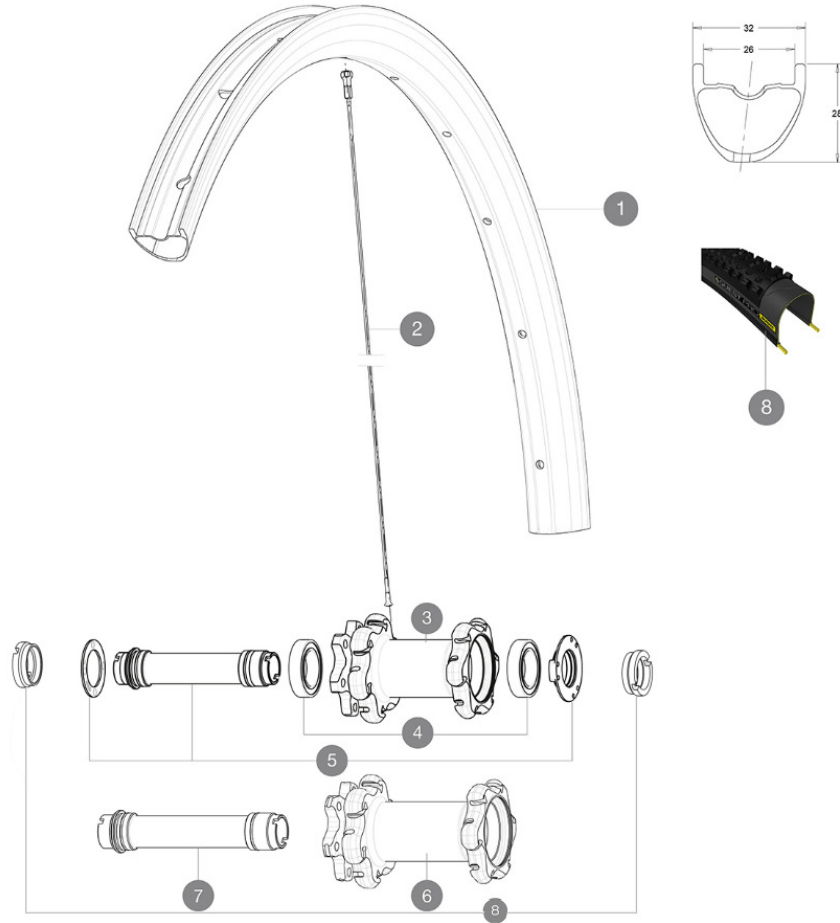

RIMS



Ã□□Ã□«Ã□□Ç©'Ã¼¼¼¼MMí¼¼¼¼¼6,5 :

| | | |
|---|----------|--|
| 1 | V3040110 | KIT FRONT RIM XA PRO CARBON 27,5" |
| | V2700101 | UST Tape 28mm for 25 to 27mm wide rims |

SPOKES

| | | |
|---|----------|--|
| 2 | V2385001 | KIT 12 FRONT + REAR NON-DRIVE SIDE BUTTED SPOKES 272mm XA PR |
|---|----------|--|

HUB SHELLS

| | | |
|---|----------|---------------------------------------|
| 3 | N/A | HUB BODY |
| 4 | 99688501 | BEARING KIT 9/15 D6T HUB |
| 5 | V2252301 | MY16 FRONT AXLE ROAD DISC 9/12/15 INT |
| 6 | N/A | HUB BODY |
| 7 | V2370701 | KIT FRONT QRM+ AXLE BOOST INTL 110mm |

OPTIONS

| | |
|----------|--|
| V2650201 | ADAPTER Front Torque Cap 15x31 MTB QRM + |
|----------|--|

TYRES









| | | |
|---|----------|---------------------|
| 8 | 39243324 | Quest Pro 27,5x2.40 |
|---|----------|---------------------|

ADAPTERS

| | | |
|---|----------|-------------------------------|
| 8 | B4104401 | 15mm FT Road Axle Adapters 16 |
| | B4104301 | 9mm FT road Axle Adapters 16 |

MAVIC XA Pro Carbon

付属品

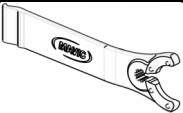
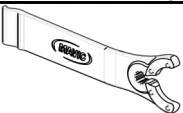
| | |
|---|---|
| 1 bottle of Mavic Sealant (355 466 01) 1 |  |
| BX601 quick releases (V24 503 01 frt, V24 504 01 rear) 1 |  |
| BX601 quick releases (V24 503 01 frt, V24 504 01 rear) 1 |  |
| Front QR adapters (996 941 01 for MTB or B41 043 01 for road) 1 |  |
| Front QR adapters (996 941 01 for MTB or B41 043 01 for road) 1 |  |
| ITS4 TS2 QRA (308 731 01) | |
| Rear 12x142mm adapters for ITS4 and TS2 (308 593 01 for ITS4, 329 650 01 for TS2) 1 |  |
| Rear 12x142mm adapters for ITS4 and TS2 (308 593 01 for ITS4, 329 650 01 for TS2) 1 |  |
| UST valve and accessories (129 838 01) |  |
| UST valve and accessories (129 838 01) |  |
| Tubeless rim tape | |
| Tubeless rim tape | |
| Multifunction adjustment wrench (325 423 01) 1 |  |
| Multifunction adjustment wrench (325 423 01) 1 |  |
| User guide | |
| User guide | |

COMPATIBILITY

| | |
|---|--|
| Freewheel: Shimano/Sram, convertible to XD with optional driver body | |
| Freewheel: Shimano/Sram or XD | |
| Front axle: convertible from 15mm thru axle to Quick Release with included adapters | |
| Front axle: convertible from 15mm thru axle to Quick Release with included adapters | |
| Rear axle: 12mm thru axle, convertible to Quick Release with optional adapters | |
| Rear axle: 12mm thru axle, convertible to Quick Release with included adapters | |

Specifications

リム

- Material : 100% Unidirectional carbon fiber
- Material : 100% Unidirectional carbon fiber

Drilling : traditional 8-14 / Update date: 2022-08-21

- Drilling : traditional
- Valve hole diameter : 6.5 mm

ホイールハブ

- Front and rear bodies : aluminum
- Front and rear bodies : aluminum

•Axle material : aluminum

- Axle material : aluminum
- Adjustable sealed cartridge bearings

ホイールの重み

ホイール重量 (クイックリリースおよびクリンチャー/チューブラーを除く) (g) :

Weight Front 27.5": 715