



# Ksyrium Elite Allroad Disc UST

ASTM CATEGORY 2 : road and offroad with jumps less than 15cm  
 For a longer longevity of the wheel, Mavic recommends that the total weight supported by the wheels don't exceed 120kg, bike included  
 Recommended tyre sizes: 28 to 42 mm  
 Max. Pressure: 28mm 7.7 bars - 110 PSI / 30mm 5.8 bars - 85 PSI

## 参照ホイール

R83001	KsyElAIRD6BRr 12x142	R86701	KsyElAIRDCLRr 12x142
--------	----------------------	--------	----------------------

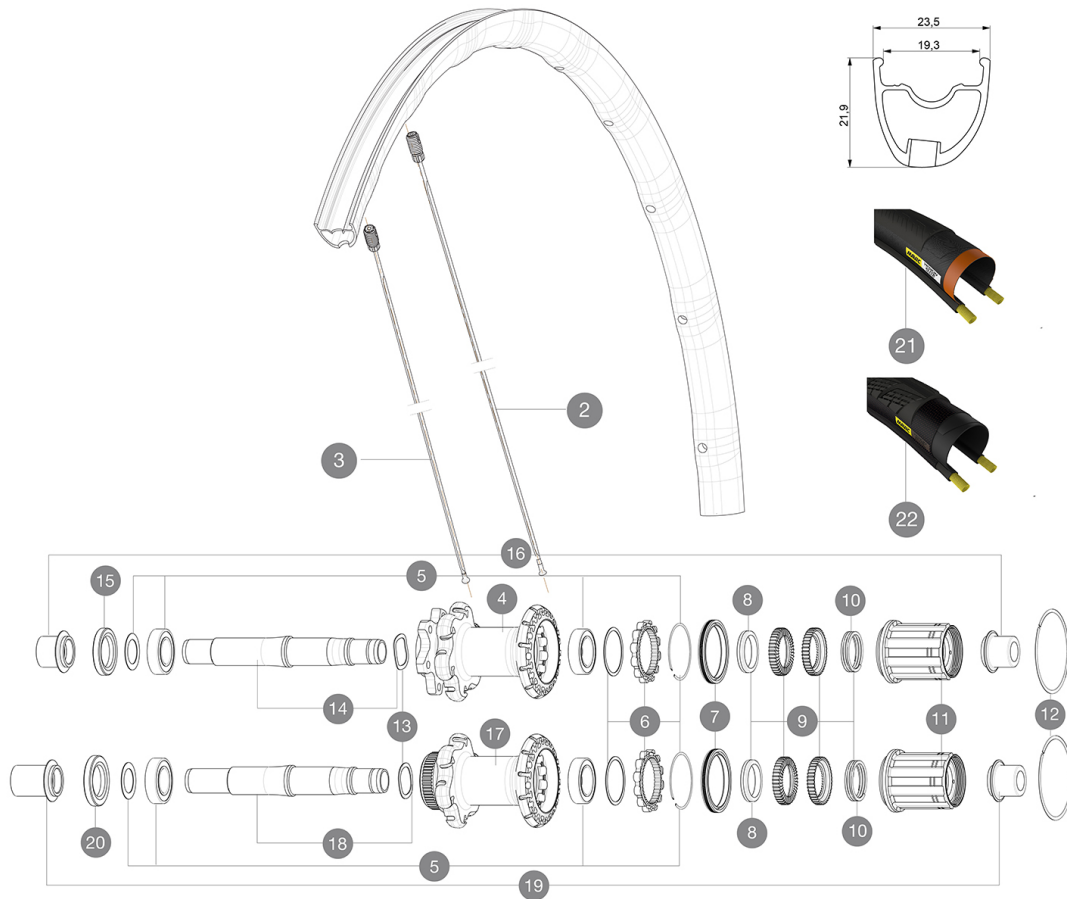

## RIMS



&NBSP;:

1	V2405813	KIT REAR RIM KSYRIUM ELITE ALLROAD
---	----------	------------------------------------

## SPOKES

2	V2273201	KIT 12 FRT/NON DRIVE SIDE BUTTED SPOKE 297mm
3	V2273301	KIT 12 REAR DRIVE SIDE BUTTED SPOKES 279mm

## HUB SHELLS

4	N/A	HUB BODY
5	V2560201	KIT ID360 BEARINGS 15/28/7 + 17/28/7
6	V2252701	KIT ID360 INSERT SHAPED EAR LOBE > 2017
7	V2251601	ID360 SEAL + GREASE
8	V2500501	Kit 3 ID360 pad for noise reduction
9	V2251701	ID360 2 RATCHETS + SPRING + GREASE
10	V2251801	KIT 3 ID360 ROAD SPRINGS
11	V3430101	HG11 Freewheel Body ID360
12	V2252201	KIT 2 REAR HUB RETENTION RINGS 48mm
13	V2251501	3 ID360 WAVE WASHERS
14	V2251301	ID360 AXLE DISC 6T
15	V2251001	KIT ID360 HUB THREADED CAP UB+DISC 6 BOLTS (large) - while s
17	N/A	HUB BODY
18	V2251401	ID360 AXLE DISC CL
20	V2251101	KIT ID360 HUB THREADED CAP DISC CENTER LOCK

## TYRES

21	37805628	Yksion Elite Guard 16 White 28
22	38012230	Yksion Elite Allroad 30





## ADAPTERS

16	B4989601	Rear Axle Adapters 12/142 INT
19	B4989901	Rear Axle Adapters 12/142 CL



# Ksyrium Elite Allroad Disc UST

## 付属品

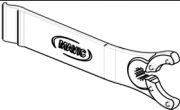
1 bottle of Mavic Sealant (355 466 01) 1	
Front 12 mm adapters (B4104201) 1	
Rear 12x142mm adapters for Instant Drive 360 (B49 896 01 for ID360 6T, B49 899 01 for ID360 CL) 1	
UST valve and accessories (129 838 01)	
Specific disc bolts (308 719 01) Pack of 6	
Multifunction adjustment wrench (325 423 01) 1	
User guide	

## COMPATIBILITY

Freewheel: Shimano/Sram, convertible to Campagnolo and XD-R with optional driver bodies	
Front axle: convertible from 12mm thru axle to quick release or 15mm thru axle with optional adapters	
Rear axle: 12mm thru axle, convertible to Quick Release with optional adapters	

## Specifications

### リム

- Material : Maxtal
- Height : 26mm, asymmetrical
- Joint : SUP
- Drilling : Fore
- Disc brake specific profile
- Weight reduction : ISM 4D
- Valve hole diameter : 6.5 mm
- Tyre : UST Tubeless and tubetype
- Internal width : 19 mm
- ETRTO size : 622x19C

### スポーク

- Material : steel
- Shape : straight pull, bladed
- Nipples : Fore integrated aluminum
- Count : 24 front and rear
- Lacing : front crossed 2, rear Isopulse

### ホイールハブ

- Front and rear bodies : aluminum
- Axle material : aluminum
- Sealed cartridge bearings
- Freewheel : Instant Drive 360
- Front : Quick release, 12 and 15mm through axle compatible
- Rear : convertible to 12mm through axle (135 and 142)

### VERSIONS

- Color : Black only
- Disc standard : 6 Bolts or Center Lock(R)

### ホイールの重み

ホイール重量 (クイックリリースおよびクリンチャー/チューブラーを除く) (g) : 910