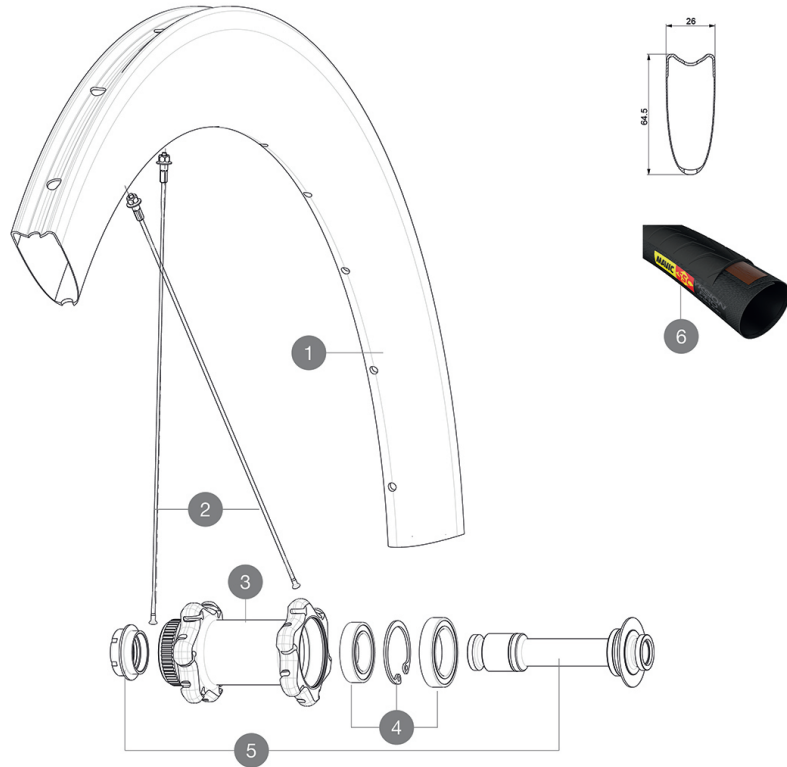

**MAVIC** *Comete Pro Carbon SL T Disc*

ASTM CATEGORY 2 : road and offroad with jumps less than 15cm  
 Recommended weight limit : 120kg  
 Recommended tire sizes: 25 to 32 mm  
 Max. Pressure: 23mm 8.7 bars - 125 psi, 25/28mm 7.7 bars - 110 psi  
 Max. Pressure: 25mm 7.7 bars - 110 PSI

**REFERENCES WHEELS**

F66601 ComProCarSiTDCLF12x100

**RIMS**

&amp;NBSP;:

1	V2731210	KIT FRONT RIM COMETE PRO CARBON SL T DISC
---	----------	---

**SPOKES**

2	V3662301	KIT 12 FRT/NDS COMETE PRO CARB SL T/UST D & DS COSMIC PRO CA
2	V2278601	KIT 12 FT/NDS BUTTED AERO SPOKE 253mm - while stock last
2	V2278501	KIT 1 FT 247/FT 253/DS 236 COMETE PRO CARB SL T D SPK

**HUB SHELLS**

3	N/A	HUB BODY
4	99688601	BEARING KIT 9/15 DCL HUB 20x32x7 6804 + 25x37x7 6805
5	V2390701	KIT FRONT 12mm AXLE QRM+ CL

**OPTIONS**

V2252401	KIT MY16 FRONT AXLE ROAD DISC 9/12/15 CL
----------	--

**TYRES**







6	37804425	Yksion Pro GripTub SSC
---	----------	------------------------

**ADAPTERS**

B4104401	ADAPTER Ft 15mm QRM+
V2680301	"Kit Ft Road Adapter 12 >> 9mm"

# MAVIC Comete Pro Carbon SL T Disc

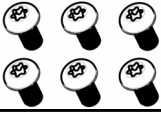
## DELIVERED WITH

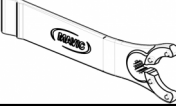
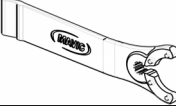
Front 12 mm adapters (B4104201) 1	
Rear 12x142mm adapters for Instant Drive 360 (B49 896 01 for ID360 6T, B49 899 01 for ID360 CL) 1	
Valve extender (118 952 01) 1	
Valve extender (118 952 01) 1	
Specific disc bolts (308 719 01) Pack of 6	
Specific disc bolts (308 719 01) Pack of 6	
Multifunction adjustment wrench (325 423 01) 1	
Multifunction adjustment wrench (325 423 01) 1	
User guide	
User guide	

## COMPATIBILITY

Freewheel: Shimano/Sram or Campagnolo, convertible to XD-R with optional driver body	
Front axle: convertible from 12mm thru axle to quick release or 15mm thru axle with optional adapters	
Front axle: convertible from 12mm thru axle to quick release or 15mm thru axle with optional adapters	
Rear axle: 12mm thru axle, convertible to Quick Release with optional adapters	
Rear axle: 12mm thru axle, convertible to Quick Release with optional adapters	

## Specifications

### RIMS

- Material : 3K carbon fibers
- Material : 3K carbon fibers
- Height : 64mm
- Height : 64mm
- Drilling : traditional
- Drilling : traditional

Disc brake specific profile  
Disc brake specific profile

- Valve hole diameter : 6.5 mm
- Valve hole diameter : 6.5 mm
- Tire : tubular
- Tire : tubular
- ETRTO size : 28" tubular
- ETRTO size : 28" tubular

### SPOKES

- Material : steel
- Material : steel
- Shape : straight pull, bladed, double butted
- Shape : straight pull, aero, double butted
- Nipples : aluminum, ABS
- Nipples : aluminum, ABS
- Count : 24 front and rear
- Count : 24 front and rear
- Lacing : front crossed 2, rear Isopulse
- Lacing : front crossed 2, rear Isopulse

### WHEEL HUB

- Front and rear bodies : aluminum
- Front and rear bodies : aluminum
- Axle material : aluminum
- Axle material : aluminum
- Front bearings : adjustable sealed cartridge bearings (QRM+), Rear bearings auto adjust sealed cartridge bearings (QRM Auto)
- Sealed cartridge bearings
- Freewheel : Instant Drive 360
- Freewheel : Instant Drive 360
- Front : Quick release, 12 thru and 15 thru compatible
- Rear : 12x142 (convertible to quick release with optional adapters)

### VERSIONS

- Color : Black only
- Color : Black only
- Disc standard : Center Lock(R) only
- Disc standard : Center Lock(R) only

### WHEEL WEIGHTS

Wheel weight 765