

MAVIC *Comete Pro Carbon SL C Disc*

ASTM CATEGORY 1 : road only

Recommended weight limit : 120kg

Recommended tire sizes: 25 to 32 mm

Max. Pressure tubeless: 25mm 6 bars - 87 PSI, 28mm 5 bars - 70 PSI. Max pressure tubetype: 25mm 7 bars - 102 PSI

Max. Pressure: 25mm 7.7 bars - 110 PSI

REFERENCES WHEELS

F66701	ComPCarSI USTD6BF12x100	F71881	ComPCarbSLCD12x100FLCLCus
F66801	ComPCarSI USTDCLF12x100		

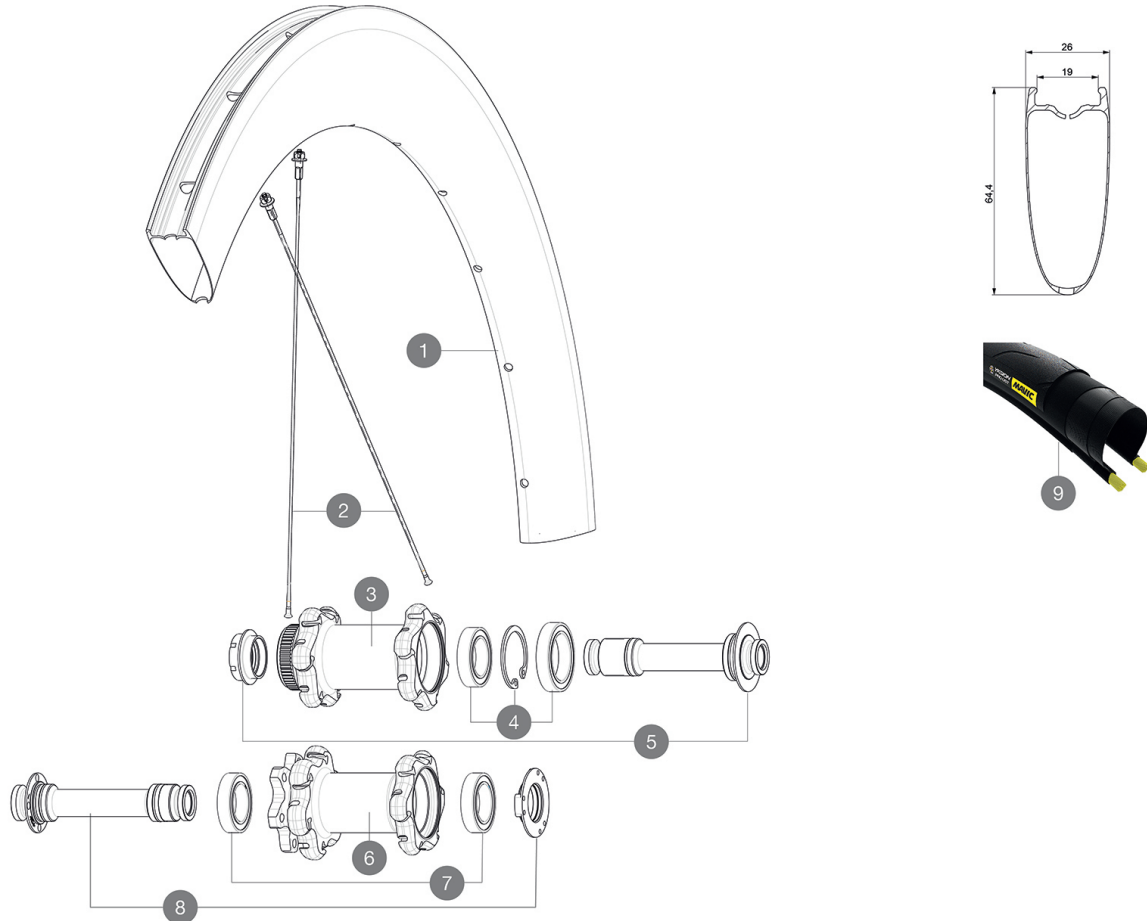
**RIMS**

&NBSP;:

1	V4093115	Kit Front/Rear rim Cosmic SL 65 Disc while stock lasts
1	V2732810	KIT FRONT RIM COMETE PRO CARBON SL UST DISC - while stock la
	V2620101	UST RIM TAPE 25mm (for 21-24mm wide rim)

SPOKES

2	V2278501	KIT 1 FT 247/FT 253/DS 236 COMETE PRO CARB SL T D SPK
2	V3662301	KIT 12 FRT/NDS COMETE PRO CARB SL T/UST D & DS COSMIC PRO CA
2	V2278601	KIT 12 FT/NDS BUTTED AERO SPOKE 253mm - while stock last

HUB SHELLS

3	N/A	HUB BODY
4	99688601	BEARING KIT 9/15 DCL HUB 20x32x7 6804 + 25x37x7 6805
5	V2390701	KIT FRONT 12mm AXLE QRM+ CL
6	N/A	HUB BODY
7	M40076	HUB BEARINGS 17x30x7 6903 x 2
8	V2390601	KIT FRONT 12mm AXLE QRM+ 6B

OPTIONS





V2252401	KIT MY16 FRONT AXLE ROAD DISC 9/12/15 CL
V2252301	KIT MY16 FRONT AXLE ROAD DISC 9/12/15 INT

ADAPTERS

V2680301	"Kit Ft Road Adapter 12 >> 9mm"
B4104401	ADAPTER Ft 15mm QRM+

MAVIC Comete Pro Carbon SL C Disc

DELIVERED WITH

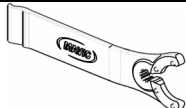
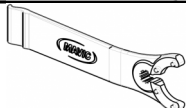
Mavic tyre sealant (rear wheel) (355 466 01)	
Tyre sealant syringe	
Front 12 mm adapters (B4104201) 1	
Rear 12x142mm adapters for Instant Drive 360 (B49 896 01 for ID360 6T, B49 899 01 for ID360 CL) 1	
UST valve and accessories (129 838 01)	
Valve extender (118 952 01) 1	
Specific disc bolts (308 719 01) Pack of 6	
Specific disc bolts (308 719 01) Pack of 6	
Tubeless rim tape	
Rim tape	
Multifunction adjustment wrench (325 423 01) 1	
Multifunction adjustment wrench (325 423 01) 1	
User guide	
User guide	

COMPATIBILITY

Freewheel: Shimano/Sram, convertible to Campagnolo and XD-R with optional driver bodies	
Freewheel: Shimano/Sram or Campagnolo, convertible to XD-R with optional driver body	
Front axle: convertible from 12mm thru axle to quick release or 15mm thru axle with optional adapters	
Front axle: convertible from 12mm thru axle to quick release or 15mm thru axle with optional adapters	
Rear axle: 12mm thru axle, convertible to Quick Release with optional adapters	
Rear axle: 12mm thru axle, convertible to Quick Release with optional adapters	

Specifications

RIMS

- Material : 3K carbon fibers
- Material : 3K carbon fibers
- Height : 64mm
- Height : 64mm
- Drilling : traditional
- Drilling : traditional
- Disc brake specific profile
- Disc brake specific profile
- Valve hole diameter : 6.5 mm
- Valve hole diameter : 6.5 mm
- Tire : clincher
- Tyre : UST Tubeless and tubetype
- Internal width : 17 mm
- Internal width : 19 mm
- ETRTO size : 622x17C

WHEEL HUB

- Front and rear bodies : aluminum
- Front and rear bodies : aluminum
- Axle material : aluminum
- Axle material : aluminum
- Front bearings : adjustable sealed cartridge bearings (QRM+), Rear bearings auto adjust sealed cartridge bearings (QRM Auto)
- Sealed cartridge bearings
- Freewheel : Instant Drive 360
- Freewheel : Instant Drive 360
- Front : Quick release, 12 thru and 15 thru compatible
- Rear : 12x142 (convertible to quick release with optional adapters)

WHEEL WEIGHTS

Wheel weight 845