

ASTM CATEGORY 3 : offroad with jumps less than 61cm
Recommended weight limit : 120kg
Recommended tire sizes: 28 mm to 62 mm (1.1" to 2.5")

REFERENCES WHEELS

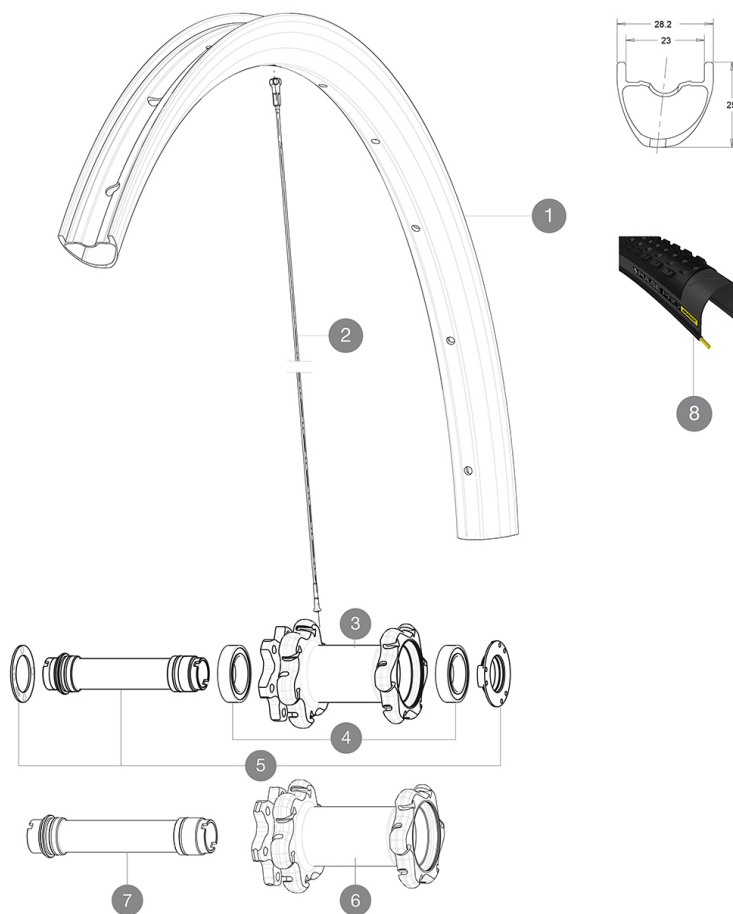

RIMS



VALVE HOLE (MM): 6,5 :

1	V3100110	KIT FRONT RIM CROSSMAX PRO CARBON 29"
	V2620101	UST RIM TAPE 25mm (for 21-24mm wide rim)

SPOKES

2	V2384601	KIT 12 FT/ND5 CROSSMAX PRO CARB 29" SPK 292mm
---	----------	---

HUB SHELLS

3	N/A	HUB BODY
4	99688501	BEARING KIT 9/12/15 D6T HUB 20x32x7 6804
5	V2252301	KIT MY16 FRONT AXLE ROAD DISC 9/12/15 INT
6	N/A	HUB BODY
7	V2370701	KIT FRONT QRM+ AXLE BOOST INTL 110mm

OPTIONS

V2650201	ADAPTER Front Torque Cap 15x31 MTB QRM +
----------	--

TYRES







8	39243232	Pulse Pro 29
8	39243221	Pulse Pro 29

ADAPTERS

B4104301	ADAPTER Ft 9mm QR QRM+
----------	------------------------

MAVIC Crossmax Pro Carbon 29

DELIVERED WITH

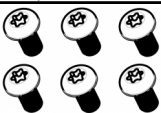
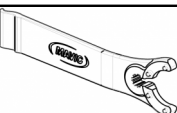
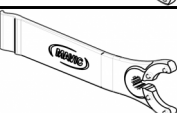
1 bottle of Mavic Sealant (355 466 01) 1	
BX601 quick releases (V24 503 01 frt, V24 504 01 rear) 1	
Front QR adapters (996 941 01 for MTB or B41 043 01 for road) 1	
Rear 12x142mm adapters for ITS4 and TS2 (308 593 01 for ITS4, 329 650 01 for TS2) 1	
UST valve and accessories (129 838 01)	
UST valve and accessories (129 838 01)	
Specific disc bolts (308 719 01) Pack of 6	
Tubeless rim tape	
Tubeless rim tape	
Multifunction adjustment wrench (325 423 01) 1	
Multifunction adjustment wrench (325 423 01) 1	
User guide	
User guide	

COMPATIBILITY

Freewheel: Shimano/Sram, convertible to XD with optional driver body	
Freewheel: Shimano/Sram or XD	
Front axle: convertible from 15mm thru axle to Quick Release with included adapters	
Front axle: convertible from 15mm thru axle to Quick Release with included adapters	
Rear axle: 12mm thru axle, convertible to Quick Release with optional adapters	

Specifications

RIMS

- **Material** : 100% Unidirectional carbon fiber
- **Material** : 100% Unidirectional carbon fiber
- **Joint** : SUP
- **Drilling** : traditional
- **Drilling** : traditional
- **Valve hole diameter** : 6.5 mm
- **Valve hole diameter** : 6.5 mm
- **Tire** : UST Tubeless and tubetype
- **Tire** : UST Tubeless and tubetype
- **Internal width** : 23 mm
- **Internal width** : 23 mm
- **ETRTO size 27.5"** : 584x23ss
- **ETRTO size 27.5"** : 584x23ss
- **ETRTO size 29"** : 622x23ss
- **ETRTO size 29"** : 622x23ss

Hookless profile

Hookless profile

Use with Mavic Tubeless Tape date: 2022-05-31

Use with Mavic Tubeless Tape

WHEEL HUB

- **Front and rear bodies** : aluminum
- **Front and rear bodies** : aluminum
- **Axle material** : aluminum
- **Axle material** : aluminum
- Adjustable sealed cartridge bearings
- Adjustable sealed cartridge bearings
- **Freewheel** : ITS-4 alloy
- **Freewheel** : ITS-4 alloy

VERSIONS

- **Color** : Black only
- **Color** : Black only
- **Disc standard** : 6 Bolts only
- **Disc standard** : 6 Bolts only
- **Hub width** : Boost (front 110, rear 148) or Non-Boost (front 100, rear 135/142)
- **Hub width** : Boost (front 110, rear 148) or Non-Boost (front 100, rear 135/142)
- Lefty Supermax
- Lefty Supermax

WHEEL WEIGHTS

Wheel weight
Weight Front 27.5": 680
Weight Front 29": 700