

MAVIC Comete Pro Carbon SL C Disc

ASTM CATEGORY 1 : road only

Recommended weight limit : 120kg

Recommended tire sizes: 25 to 32 mm

Max. Pressure tubeless: 25mm 6 bars - 87 PSI, 28mm 5 bars - 70 PSI. Max pressure tubetype: 25mm 7 bars - 102 PSI

Max. Pressure: 25mm 7.7 bars - 110 PSI

REFERENCES WHEELS

| | | | |
|--------|-------------------------|--------|---------------------------|
| F66701 | ComPCarSI USTD6BF12x100 | F71881 | ComPCarbSLCD12x100FLCLCus |
| F66801 | ComPCarSI USTDCLF12x100 | | |

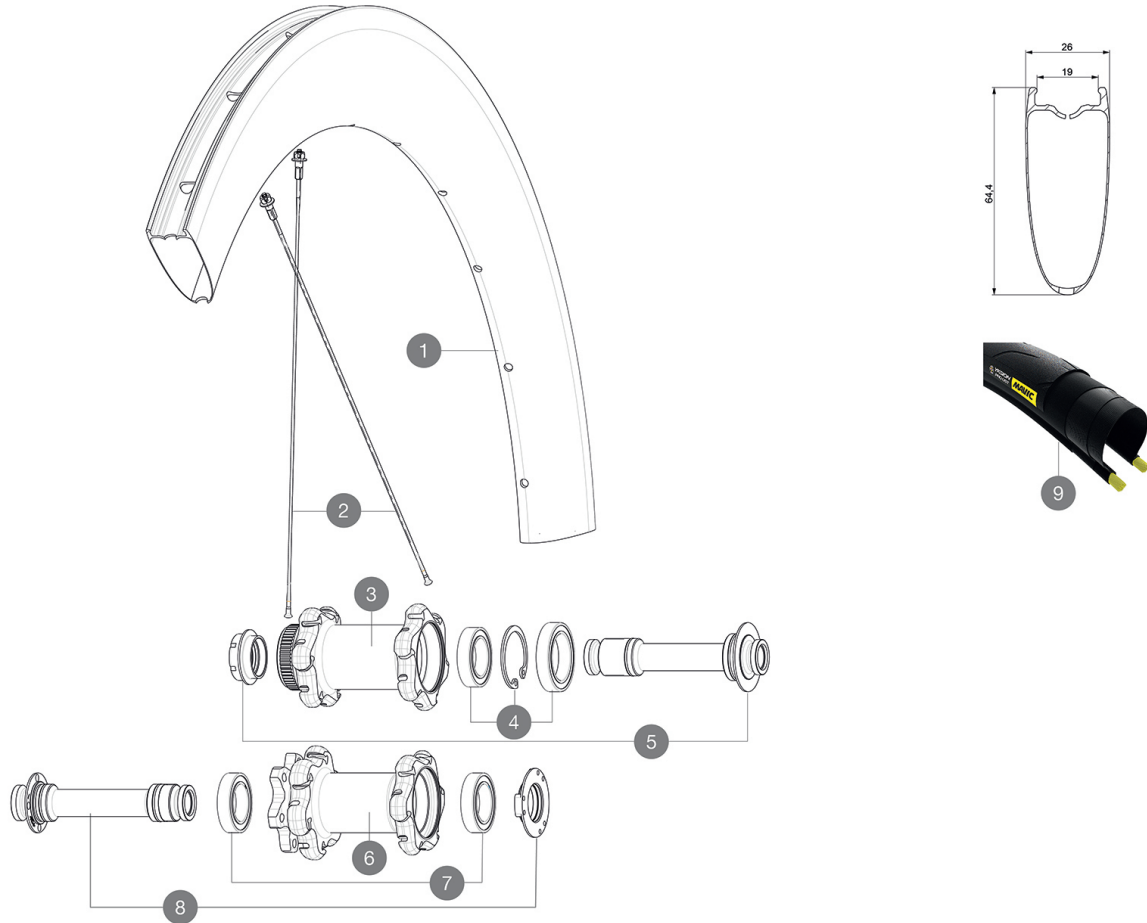

RIMS



&NBSP;:

| | | |
|---|----------|--|
| 1 | V4093115 | Kit Front/Rear rim Cosmic SL 65 Disc while stock lasts |
| 1 | V2732810 | KIT FRONT RIM COMETE PRO CARBON SL UST DISC - while stock la |
| | V2620101 | UST RIM TAPE 25mm (for 21-24mm wide rim) |

SPOKES

| | | |
|---|----------|--|
| 2 | V3662301 | KIT 12 FRIT/ND S COMETE PRO CARB SL T/UST D & DS COSMIC PRO CA |
| 2 | V2278601 | KIT 12 FT/ND S BUTTED AERO SPOKE 253mm - while stock last |
| 2 | V2278501 | KIT 1 FT 247/FT 253/DS 236 COMETE PRO CARB SL T D SPK |

HUB SHELLS

| | | |
|---|----------|--|
| 3 | N/A | HUB BODY |
| 4 | 99688601 | BEARING KIT 9/15 DCL HUB 20x32x7 6804 + 25x37x7 6805 |
| 5 | V2390701 | KIT FRONT 12mm AXLE QRM+ CL |
| 6 | N/A | HUB BODY |
| 7 | M40076 | HUB BEARINGS 17x30x7 6903 x 2 |
| 8 | V2390601 | KIT FRONT 12mm AXLE QRM+ 6B |

OPTIONS





| | |
|----------|---|
| V2252401 | KIT MY16 FRONT AXLE ROAD DISC 9/12/15 CL |
| V2252301 | KIT MY16 FRONT AXLE ROAD DISC 9/12/15 INT |

ADAPTERS

| | |
|----------|---------------------------------|
| B4104401 | ADAPTER Ft 15mm QRM+ |
| V2680301 | "Kit Ft Road Adapter 12 >> 9mm" |

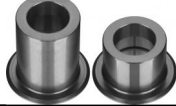
MAVIC Comete Pro Carbon SL C Disc

DELIVERED WITH

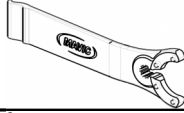
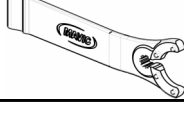
| | |
|---|---|
| Mavic tyre sealant (rear wheel) (355 466 01) | |
| Tyre sealant syringe | |
| Front 12 mm adapters (B4104201) 1 |  |
| Rear 12x142mm adapters for Instant Drive 360 (B49 896 01 for ID360 6T, B49 899 01 for ID360 CL) 1 |  |
| UST valve and accessories (129 838 01) | |
| Valve extender (118 952 01) 1 |  |
| Specific disc bolts (308 719 01) Pack of 6 |  |
| Specific disc bolts (308 719 01) Pack of 6 |  |
| Tubeless rim tape | |
| Rim tape | |
| Multifunction adjustment wrench (325 423 01) 1 |  |
| Multifunction adjustment wrench (325 423 01) 1 |  |
| User guide | |
| User guide | |

COMPATIBILITY

| | |
|---|--|
| Freewheel: Shimano/Sram or Campagnolo, convertible to XD-R with optional driver body | |
| Freewheel: Shimano/Sram, convertible to Campagnolo and XD-R with optional driver bodies | |
| Front axle: convertible from 12mm thru axle to quick release or 15mm thru axle with optional adapters | |
| Front axle: convertible from 12mm thru axle to quick release or 15mm thru axle with optional adapters | |
| Rear axle: 12mm thru axle, convertible to Quick Release with optional adapters | |
| Rear axle: 12mm thru axle, convertible to Quick Release with optional adapters | |

Specifications

RIMS

- Material : 3K carbon fibers
- Material : 3K carbon fibers
- Height : 64mm
- Height : 64mm
- Drilling : traditional
- Drilling : traditional
- Disc brake specific profile
- Disc brake specific profile
- Valve hole diameter : 6.5 mm
- Valve hole diameter : 6.5 mm
- Tire : clincher
- Tyre : UST Tubeless and tubetype
- Internal width : 17 mm
- Internal width : 19 mm
- ETRTO size : 622x17C

WHEEL HUB

- Front and rear bodies : aluminum
- Front and rear bodies : aluminum
- Axle material : aluminum
- Axle material : aluminum
- Front bearings : adjustable sealed cartridge bearings (QRM+), Rear bearings auto adjust sealed cartridge bearings (QRM Auto)
- Sealed cartridge bearings
- Freewheel : Instant Drive 360
- Freewheel : Instant Drive 360
- Front : Quick release, 12 thru and 15 thru compatible
- Rear : 12x142 (convertible to quick release with optional adapters)

WHEEL WEIGHTS

Wheel weight 845