

ASTM CATEGORY 3 : offroad with jumps less than 61cm  
 Recommended weight limit : 120kg  
 Recommended tire sizes: 28 mm to 62 mm (1.1" to 2.5")  
 Recommended tyre sizes: 36 mm to 64 mm (1.4" to 2.5")

## REFERENCES WHEELS

F54801 XmxPro27.5Ft

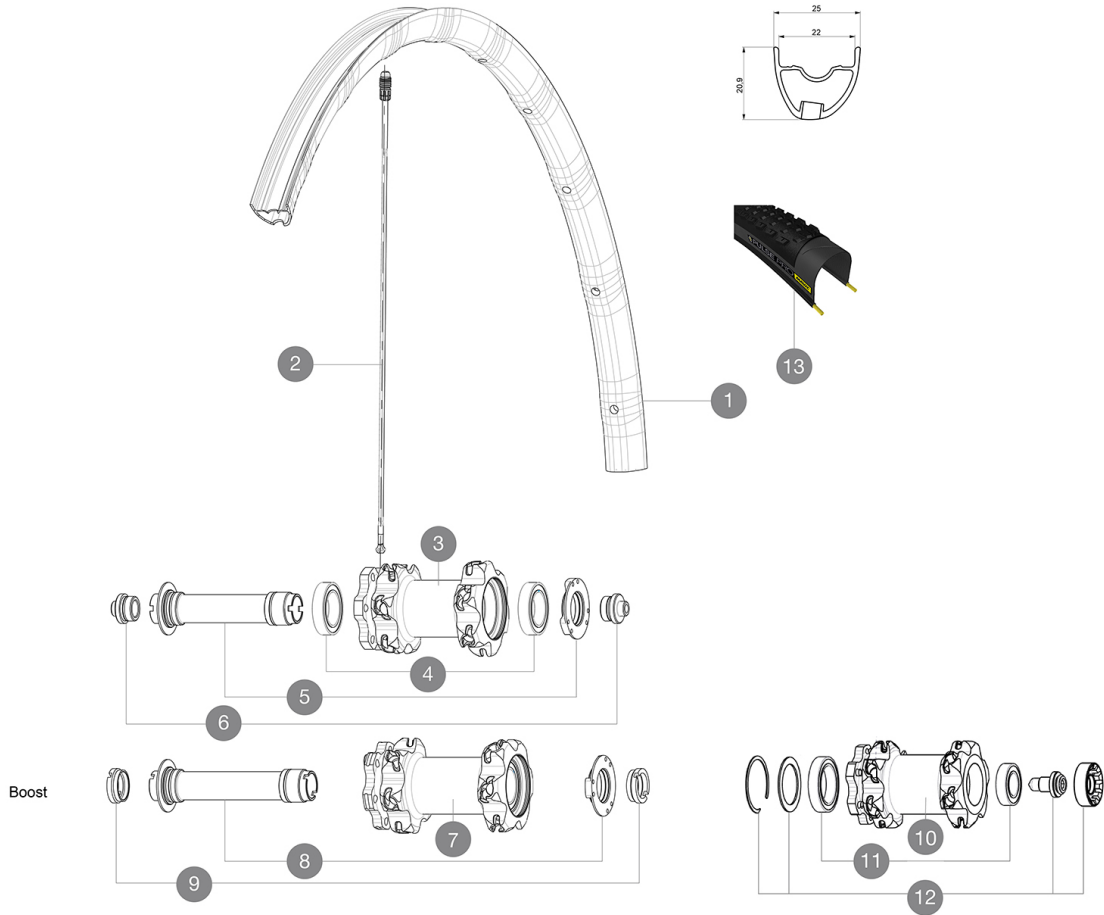

## RIMS



VALVE HOLE (MM): 6,5 :

1	V2316010	KIT FRONT RIM CROSSMAX PRO 27,5" 22mm TSS
---	----------	---

## SPOKES

2	V2386401	KIT 1 275mm 27,5" + 1 293mm 29" CROSSMAX PRO STAMPED BUTTE
2	V2384701	KIT 12 FT/NDS CROSSMAX PRO 27,5" SPK 275mm

## HUB SHELLS

3	N/A	HUB BODY
4	99688501	BEARING KIT 9/12/15 D6T HUB 20x32x7 6804
5	V2252301	KIT MY16 FRONT AXLE ROAD DISC 9/12/15 INT
7	N/A	HUB BODY
8	V2370701	KIT FRONT QRM+ AXLE BOOST INTL 110mm
10	N/A	HUB BODY
11	M40771	BEARING KIT FOR LEFTY 50 & 60 HUB
12	36709301	ASSEMBLY KIT FOR LEFTY SUPERMAX WHEELS

## OPTIONS

V2650201	ADAPTER Front Torque Cap 15x31 MTB QRM +
----------	--

## TYRES









13	39243132	Pulse Pro 27.5
13	39243121	Pulse Pro 27.5

## ADAPTERS

6	B4104301	ADAPTER Ft 9mm QR QRM+
9	B4104401	ADAPTER Ft 15mm QRM+

# MAVIC Crossmax Pro

## DELIVERED WITH

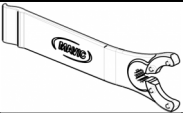
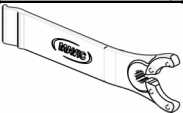
1 bottle of Mavic Sealant (355 466 01) 1	
BX601 quick releases (V24 503 01 frt, V24 504 01 rear) 1	
BX601 quick releases (V24 503 01 frt, V24 504 01 rear) 1	
Front QR adapters (996 941 01 for MTB or B41 043 01 for road) 1	
Front QR adapters (996 941 01 for MTB or B41 043 01 for road) 1	
Rear QR adapters for ITS4 and TS2 (308 731 01)	
Rear 12x142mm adapters for ITS4 and TS2 (308 593 01 for ITS4, 329 650 01 for TS2) 1	
Rear 12x142mm adapters for ITS4 and TS2 (308 593 01 for ITS4, 329 650 01 for TS2) 1	
UST valve and accessories (129 838 01)	
UST valve and accessories (129 838 01)	
Multifunction adjustment wrench (325 423 01) 1	
Multifunction adjustment wrench (325 423 01) 1	
User guide	
User guide	

## COMPATIBILITY

Freewheel: Shimano/Sram or XD	
Freewheel: Shimano/Sram, convertible to XD with optional driver body	
Front axle: convertible from 15mm thru axle to Quick Release with included adapters	
Front axle: convertible from 15mm thru axle to Quick Release with included adapters	
Rear axle: 12mm thru axle, convertible to Quick Release with optional adapters	
Rear axle: 12mm thru axle, convertible to Quick Release with included adapters	

## Specifications

### RIMS

- Material : Mxtral
- Material : Mxtral
- Joint : SUP
- Joint : SUP
- Drilling : Fore
- Drilling : Fore
- Weight reduction : ISM 4D
- Weight reduction : ISM 4D
- Valve hole diameter : 6.5 mm
- Valve hole diameter : 6.5 mm
- Tire : UST Tubeless and tubetype
- Tire : UST Tubeless and tubetype
- Internal width : 22 mm
- Internal width : 22 mm
- ETRTO size 27.5" : 584x22ss

### WHEEL HUB

- Front and rear bodies : aluminum
- Front and rear bodies : aluminum
- Axle material : aluminum
- Axle material : aluminum
- Sealed cartridge bearings
- Sealed cartridge bearings
- Freewheel : ITS-4 alloy
- Freewheel : ITS-4 alloy

### VERSIONS

- Color : Black only
- Color : Black only
- Disc standard : 6 Bolts only
- Disc standard : 6 Bolts only
- Hub width : Boost (front 110, rear 148) or Non-

### WHEEL WEIGHTS

- Wheel weight
- Weight Front 27.5": 700
- Weight Front 29": 730