

MAVIC XA Pro Carbon

2017
FRONT

ASTM CATEGORY 3 : offroad with jumps less than 61cm
Recommended weight limit : 120kg
Recommended tire sizes: 35 mm to 69 mm (1.4" to 2.7")
Recommended tyre sizes: 46mm to 64mm (1.8" to 2.5")

REFERENCES WHEELS

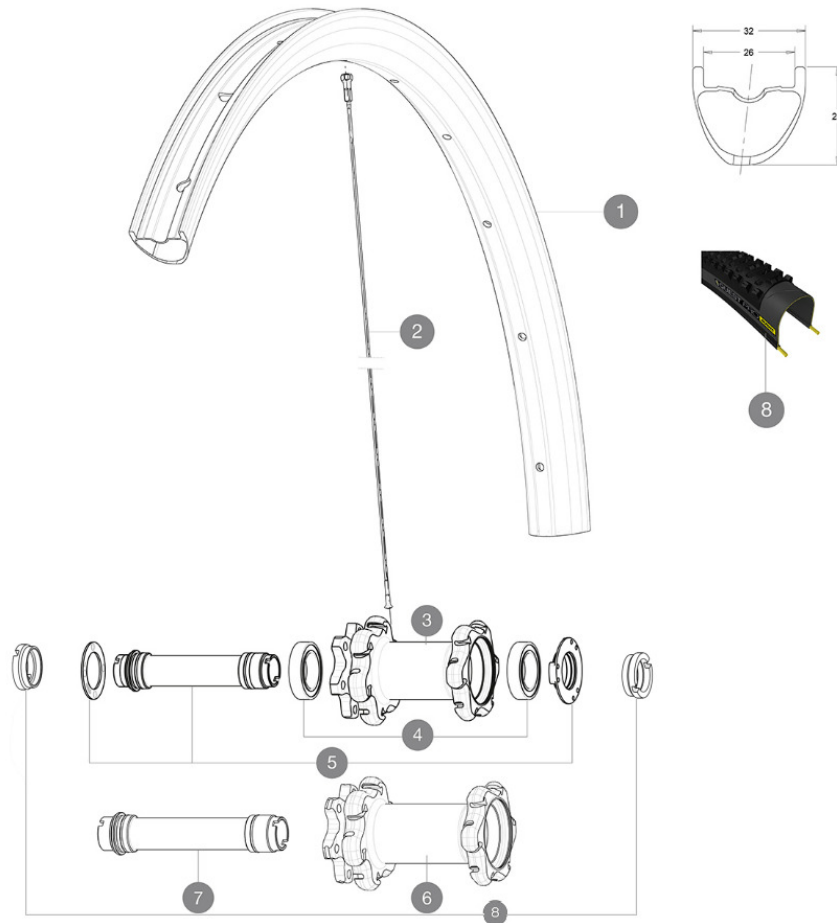

RIMS



VALVE HOLE (MM): 6,5 :

1	V3040110	KIT FRONT RIM XA PRO CARBON 27,5"
	V2700101	UST Tape 28mm for 25 to 27mm wide rims

SPOKES

2	V2385001	KIT 12 FT/NDS XA PRO CARBON 27,5" SPK 270mm
---	----------	---

HUB SHELLS

3	N/A	HUB BODY
4	99688501	BEARING KIT 9/12/15 D6T HUB 20x32x7 6804
5	V2252301	KIT MY16 FRONT AXLE ROAD DISC 9/12/15 INT
6	N/A	HUB BODY
7	V2370701	KIT FRONT QRM+ AXLE BOOST INTL 110mm

OPTIONS

V2650201	ADAPTER Front Torque Cap 15x31 MTB QRM +
----------	--

TYRES









8	39243324	Quest Pro 27.5
---	----------	----------------

ADAPTERS

8	B4104401	ADAPTER Ft 15mm QRM+
	B4104301	ADAPTER Ft 9mm QR QRM+

MAVIC XA Pro Carbon

DELIVERED WITH

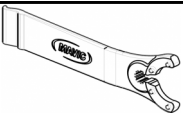
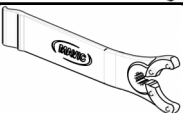
1 bottle of Mavic Sealant (355 466 01) 1	
BX601 quick releases (V24 503 01 frt, V24 504 01 rear) 1	
BX601 quick releases (V24 503 01 frt, V24 504 01 rear) 1	
Front QR adapters (996 941 01 for MTB or B41 043 01 for road) 1	
Front QR adapters (996 941 01 for MTB or B41 043 01 for road) 1	
Rear QR adapters for ITS4 and TS2 (308 731 01)	
Rear 12x142mm adapters for ITS4 and TS2 (308 593 01 for ITS4, 329 650 01 for TS2) 1	
Rear 12x142mm adapters for ITS4 and TS2 (308 593 01 for ITS4, 329 650 01 for TS2) 1	
UST valve and accessories (129 838 01)	
UST valve and accessories (129 838 01)	
Tubeless rim tape	
Tubeless rim tape	
Multifunction adjustment wrench (325 423 01) 1	
Multifunction adjustment wrench (325 423 01) 1	
User guide	
User guide	

COMPATIBILITY

Freewheel: Shimano/Sram or XD	
Freewheel: Shimano/Sram, convertible to XD with optional driver body	
Front axle: convertible from 15mm thru axle to Quick Release with included adapters	
Front axle: convertible from 15mm thru axle to Quick Release with included adapters	
Rear axle: 12mm thru axle, convertible to Quick Release with optional adapters	
Rear axle: 12mm thru axle, convertible to Quick Release with included adapters	

Specifications

RIMS

- Material : 100% Unidirectional carbon fiber
- Material : 100% Unidirectional carbon fiber
- Drilling : traditional
- Drilling : traditional
- Valve hole diameter : 6.5 mm

WHEEL HUB

- Front and rear bodies : aluminum
 - Front and rear bodies : aluminum
 - Axle material : aluminum
 - Axle material : aluminum
- Adjustable sealed cartridge bearings

WHEEL WEIGHTS

- Wheel weight
- Weight Front 27.5": 715
- Weight Front 29": 735