

## REFERENCES WHEELS

ASTM CATEGORY 1 : road only

For a longer longevity of the wheel, Mavic recommends that the total weight supported by the wheels don't exceed 120kg, bike included

Recommended tyre sizes: 25 to 32 mm

Max. Pressure tubeless: 25mm 6 bars - 87 PSI, 28mm 5 bars - 70 PSI. Max pressure tubetype: 25mm 7 bars - 102 PSI, 28mm 6 bars - 87 PSI

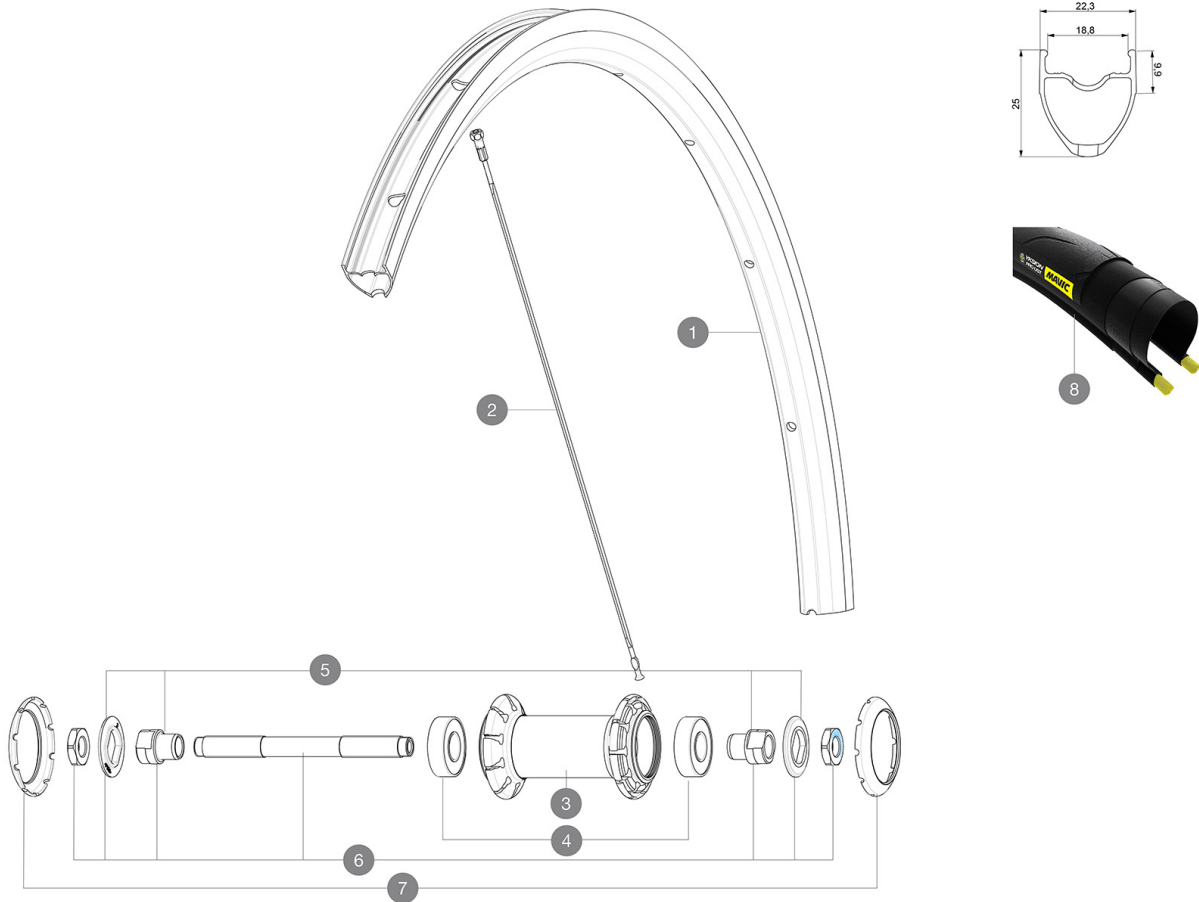

## RIMS



&NBSP;:

1	V2735015	KIT FRONT/REAR RIM AKSIUM ELITE UST UB SUP
	V3720101	25mm UST Tape for 19 to 22mm Road Rims

## SPOKES

2	V3664701	KIT 10 FRIT/NDS AKSIUM ELITE UST FLAT SPOKE 282mm + nipple
---	----------	--

## HUB SHELLS

4	M40318	KIT 2 HUB BEARINGS 6001
5	99603801	SHORT EXPENSIBLE BEARING SUPPORTS > 2008
6	99603701	FRONT AXLE QRM ROAD 2008
7	12034401	KIT 3 HUB CAPS AERO 10 SLOTS BLACK

## TYRES

8	39938825	Yksion Pro UST 700x25
8	39938828	Yksion Pro UST 700x28

# MAVIC Aksium Elite UST

## DELIVERED WITH

Mavic tyre sealant (rear wheel) (355 466 01)	
Tyre sealant syringe	
BR101 quick releases (M40350 frt, M40351 rear road, M40352 rear MTB)	
UST valve and accessories (129 838 01)	
Tubeless rim tape	
User guide	

## COMPATIBILITY

Freewheel: Shimano/Sram, convertible to Campagnolo with optional driver body	
Front axle: Quick Release only	
Rear axle: Quick Release only	

## Specifications

### RIMS

- **Material** : S6000 Aluminum
  - **Height** : 25mm
  - **Joint** : SUP
  - **Drilling** : traditional
  - **Brake track** : UB Control
  - **Valve hole diameter** : 6.5 mm
  - **Tyre** : UST Tubeless and tubetype
  - **Internal width** : 19 mm
  - **ETRTO size** : 622x19TC Road
- Use with Mavic Tubeless Tape

### SPOKES

- **Material** : steel
- **Shape** : straight pull, flat, double butted
- **Nipples** : steel, ABS
- **Count** : 20 front and rear
- **Lacing** : radial front and rear non-drive side, crossed 2 rear drive side

### WHEEL HUB

- **Front and rear bodies** : aluminum
  - **Axle material** : steel
- Sealed cartridge bearings (QRM)
- **Freewheel** : FTS-L steel

### WHEEL WEIGHTS

825