

# MAVIC Ksyrium Elite Allroad Disc UST

2017  
REAR

ASTM CATEGORY 2 : road and offroad with jumps less than 15cm  
Recommended weight limit : 120kg  
Recommended tire sizes: 28 to 42 mm  
Max. Pressure: 28mm 7.7 bars - 110 PSI / 30mm 5.8 bars - 85 PSI

## REFERENCES WHEELS

R83001 KsyElAIRD6BRr 12x142 R86701 KsyElAIRDCLRr 12x142

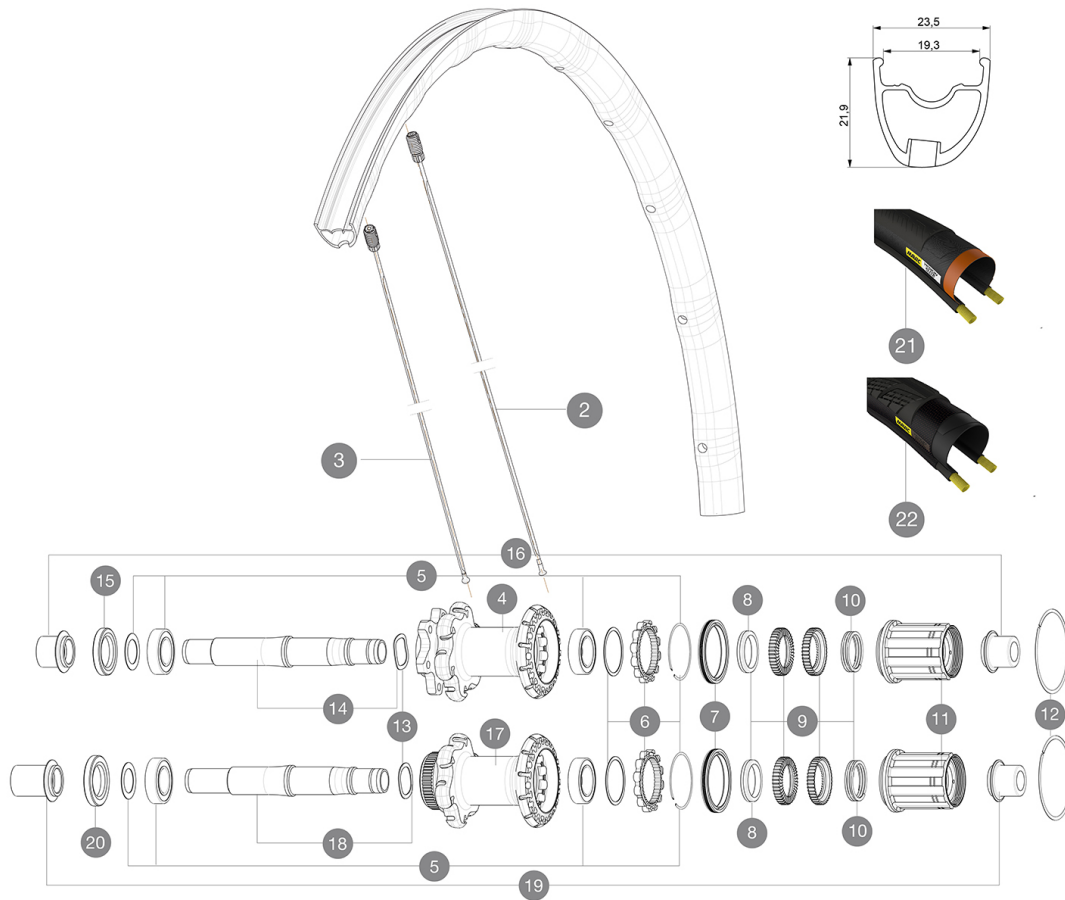

## RIMS



&NBSP;:

1 V2405813 KIT REAR RIM KSYRIUM ELITE ALLROAD

## SPOKES

2 V2273201 KIT 12 FRT/NON DRIVE SIDE BUTTED SPOKE 297mm  
3 V2273301 KIT 12 DRIVE SIDE BUTTED SPOKE 280mm

## HUB SHELLS

4	N/A	HUB BODY
5	V2560201	KIT ID360 BEARINGS 15/28/7 + 17/28/7
6	V2252701	KIT ID360 INSERT SHAPED EAR LOBE > 2017
7	V2251601	KIT ID360 SEAL + GREASE
8	V2500501	KIT ID360 3 PADS NOISE REDUCING
9	V2251701	KIT ID360 2 RATCHETS + SPRING + GREASE
10	V2251801	KIT 3 ID360 ROAD SPRINGS
11	V3430101	HG11 Freewheel Body ID360
12	V2252201	KIT 2 REAR HUB RETENTION RINGS 48mm
13	V2251501	KIT 3 ID360 WAVE WASHERS
14	V2251301	KIT ID360 AXLE DISC 6 BOLTS
15	V2251001	KIT ID360 HUB THREADED CAP UB+DISC 6 BOLTS (large) - while s
17	N/A	HUB BODY
18	V2251401	KIT ID360 AXLE DISC CENTER LOCK
20	V2251101	KIT ID360 HUB THREADED CAP DISC CENTER LOCK





## TYRES

21 37805628 Yksion EliteGuard White  
22 38012230 Yksion Elite Allroad

## ADAPTERS

16 B4989601 ADAPTER Rr 12x142mm ID360 (6bolt)  
19 B4989901 ADAPTER Rr 12x142mm ID360 (Lock)

## DELIVERED WITH

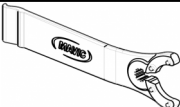
1 bottle of Mavic Sealant (355 466 01) 1	
Front 12 mm adapters (B4104201) 1	
Rear 12x142mm adapters for Instant Drive 360 (B49 896 01 for ID360 6T, B49 899 01 for ID360 CL) 1	
UST valve and accessories (129 838 01)	
Specific disc bolts (308 719 01) Pack of 6	
Multifunction adjustment wrench (325 423 01) 1	
User guide	

## COMPATIBILITY

Freewheel: Shimano/Sram, convertible to Campagnolo and XD-R with optional driver bodies	
Front axle: convertible from 12mm thru axle to quick release or 15mm thru axle with optional adapters	
Rear axle: 12mm thru axle, convertible to Quick Release with optional adapters	

## Specifications

### RIMS

- **Material** : Maxtal
- **Height** : 26mm, asymmetrical
- **Joint** : SUP
- **Drilling** : Fore

Disc brake specific profile

- **Weight reduction** : ISM 4D
- **Valve hole diameter** : 6.5 mm
- **Tire** : UST Tubeless and tubetype
- **Internal width** : 19 mm
- **ETRTO size** : 622x19C

### SPOKES

- **Material** : steel
- **Shape** : straight pull, bladed
- **Nipples** : Fore integrated aluminum
- **Count** : 24 front and rear
- **Lacing** : front crossed 2, rear Isopulse

### WHEEL HUB

- **Front and rear bodies** : aluminum
  - **Axle material** : aluminum
- Sealed cartridge bearings
- **Freewheel** : Instant Drive 360
  - **Front** : Quick release, 12 thru and 15 thru compatible
  - **Rear** : 12x142 (convertible to quick release with optional adapters)

### VERSIONS

- **Color** : Black only
- **Disc standard** : 6 Bolts or Center Lock(R)

### WHEEL WEIGHTS

Wheel weight 910