

ASTM CATEGORY 2 : road and offroad with jumps less than 15cm
 Recommended weight limit : 120kg
 Recommended tire sizes: 25 to 32 mm
 Max. Pressure: 23mm 8.7 bars - 125 psi, 25/28mm 7.7 bars - 110 psi
 Max. Pressure: 25/28mm 7.7 bars - 110 PSI

REFERENCES WHEELS

R81101 Aksium Elite 17 Rr

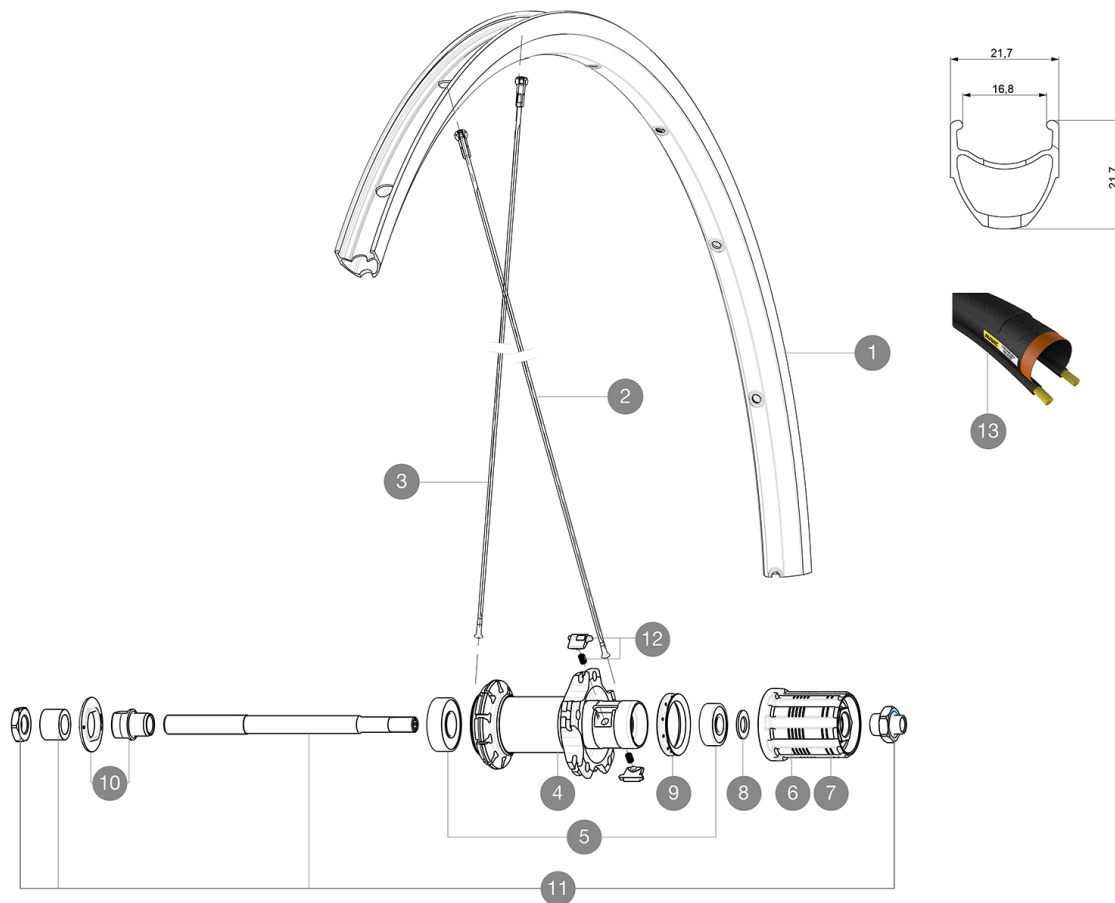

RIMS



&NBSP;:

1	V2408615	KIT FRONT/REAR RIM AKSIUM ELITE 17C - while stock last
1	V2735015	KIT FRONT/REAR RIM AKSIUM ELITE UST UB SUP

SPOKES

2	10845001	KIT 10 DS AKSIUM STEEL AERO SPOKES 299mm
3	10844901	KIT 10 FT KSYRIUM EQ S/FT+NDS AKSIUM SPK 285mm - while stock
3	V4160101	Kit 10 stainless spokes 285 Ft Ksyrium Equipe S/Ft & NDS Aks



HUB SHELLS

4	12034401	KIT 3 HUB CAPS AERO 10 SLOTS BLACK
5	M40660	REAR HUB 608+6001 BEARINGS
6	30871101	FTS-L ROAD FREEWHEEL BODY HG11 8/9 compatible
8	M40067	INTERNAL FREEWHEEL SPACER FTSL/FTSX
9	99500001	FTSL/FTSX FREEHUB BODY SEAL
10	99603801	SHORT EXPENSIBLE BEARING SUPPORTS > 2008
11	99603901	REAR AXLE QRM ROAD 2008
12	M40578	FTSL PAWLS KIT (ROAD WHEELS)

TYRES

13	37805628	Yksion EliteGuard White
13	37805625	Yksion EliteGuard White

DELIVERED WITH

BR101 quick releases (M40350 firt, M40351 rear road, M40352 rear MTB) 1	
BR101 quick releases (M40350 firt, M40351 rear road, M40352 rear MTB) 1	
Rim tape	
Rim tape	
User guide	
User guide	

COMPATIBILITY

Freewheel: Shimano/Sram, convertible to Campagnolo with optional driver body	
Freewheel: Shimano/Sram, convertible to Campagnolo with optional driver body	
Front axle: Quick Release only	
Front axle: Quick Release only	
Rear axle: Quick Release only	
Rear axle: Quick Release only	

Specifications**RIMS**

- **Material** : S6000 Aluminum
- **Material** : S6000 Aluminum
- **Height** : 22 mm
- **Height** : 21 mm
- **Joint** : sleeved
- **Joint** : sleeved
- **Drilling** : traditional with H2 reinforcement
- **Drilling** : traditional with H2 reinforcement
- **Brake track** : UB Control
- **Brake track** : UB Control
- **Valve hole diameter** : 6.5 mm
- **Valve hole diameter** : 6.5 mm
- **Tire** : clincher
- **Tire** : clincher
- **Internal width** : 17 mm
- **Internal width** : 17 mm
- **ETRTO size** : 622x17C
- **ETRTO size** : 622x17C

SPOKES

- **Material** : steel
- **Material** : steel
- **Shape** : straight pull, bladed
- **Shape** : straight pull, bladed
- **Nipples** : steel, ABS
- **Nipples** : steel, ABS
- **Count** : 20 front and rear
- **Count** : 20 front and rear
- **Lacing** : radial front and rear non-drive side, crossed 2 rear drive side
- **Lacing** : radial front and rear non-drive side, crossed 2 rear drive side

WHEEL HUB

- **Front and rear bodies** : aluminum
- **Front and rear bodies** : aluminum
- **Axle material** : steel
- **Axle material** : steel
- Sealed cartridge bearings
- Sealed cartridge bearings
- **Freewheel** : FTS-L steel
- **Freewheel** : FTS-L steel

VERSIONS

- **Color** : Black only
- **Color** : Black only

WHEEL WEIGHTS

Wheel weight 970