

ASTM CATEGORY 1 : road only
 Recommended weight limit : 120kg
 Recommended tire sizes: 25 to 32 mm
 Max. Pressure: 23mm 8.7 bars - 125 psi, 25/28mm 7.7 bars - 110 psi
 Max. Pressure: 25mm 7.7 bars - 110 PSI

REFERENCES WHEELS

F54401	Ksyrium 17 Ft Black	F54402	Ksyrium 17 Ft Blue
--------	---------------------	--------	--------------------

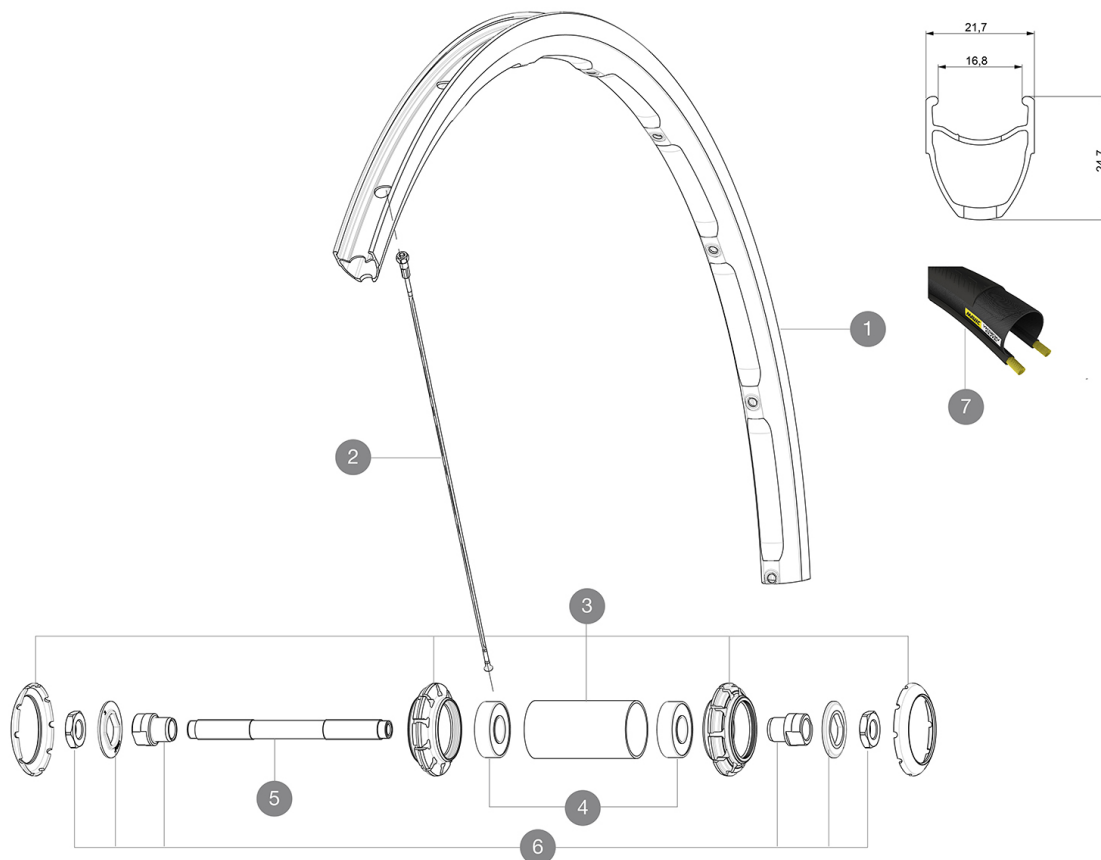

RIMS



&NBSP;:

1	V2408910	KIT FRONT RIM KSYRIUM BLACK 17C
1	V2409110	KIT FRONT RIM KSYRIUM BLUE17C

SPOKES

2	V2275901	KIT 10 FRONT AERO SPOKE 282mm + STEEL NIPPLE
---	----------	--

HUB SHELLS

3	N/A	HUB BODY
3	12034401	KIT 3 HUB CAPS AERO 10 SLOTS BLACK
4	M40318	KIT 2 HUB BEARINGS 6001
5	99603701	FRONT AXLE QRM ROAD 2008
6	99603801	SHORT EXPENSIBLE BEARING SUPPORTS > 2008

TYRES

7	37805725	Yksion Elite
---	----------	--------------

DELIVERED WITH

BR101 quick releases (M40350 firt, M40351 rear road, M40352 rear MTB) 1	
BR101 quick releases (M40350 firt, M40351 rear road, M40352 rear MTB) 1	
Rim tape	
Rim tape	
User guide	
User guide	

COMPATIBILITY

Freewheel: Shimano/Sram, convertible to Campagnolo with optional driver body	
Freewheel: Shimano/Sram, convertible to Campagnolo with optional driver body	
Front axle: Quick Release only	
Front axle: Quick Release only	
Rear axle: Quick Release only	
Rear axle: Quick Release only	

Specifications**RIMS**

- **Material** : S6000 Aluminum
- **Material** : S6000 Aluminum
- **Height** : 24 mm
- **Height** : 24 mm
- **Height** : 21 mm
- **Joint** : SUP
- **Joint** : SUP
- **Drilling** : traditional with H2 reinforcement
- **Drilling** : traditional with H2 reinforcement
- **Brake track** : UB Control
- **Brake track** : UB Control
- **Weight reduction** : ISM
- **Weight reduction** : ISM
- **Valve hole diameter** : 6.5 mm
- **Valve hole diameter** : 6.5 mm
- **Tire** : clincher
- **Tire** : clincher
- **Internal width** : 17 mm
- **Internal width** : 17 mm
- **ETRTO size** : 622x17C
- **ETRTO size** : 622x17C

SPOKES

- **Material** : steel
- **Material** : steel
- **Shape** : straight pull, bladed
- **Shape** : straight pull, bladed
- **Nipples** : steel, ABS
- **Nipples** : steel, ABS
- **Count** : 20 front and rear
- **Count** : 20 front and 24 rear
- **Lacing** : front radial, rear Isopulse
- **Lacing** : front radial, rear Isopulse

WHEEL HUB

- **Front and rear bodies** : aluminum
- **Front and rear bodies** : aluminum
- **Axle material** : steel
- **Axle material** : steel
- Sealed cartridge bearings
- Sealed cartridge bearings
- **Freewheel** : FTS-L steel
- **Freewheel** : FTS-L steel

VERSIONS

- **Color** : Black only
- **Color** : Black or Black/Blue

WHEEL WEIGHTS

Wheel weight 765