

MAVIC Ksyrium Elite Allroad Disc UST

1
2017
FRONT

ASTM CATEGORY 2 : road and offroad with jumps less than 15cm
Recommended weight limit : 120kg
Recommended tire sizes: 28 to 42 mm
Max. Pressure: 28mm 7.7 bars - 110 PSI / 30mm 5.8 bars - 85 PSI

REFERENCES WHEELS

F56201 KsyElAIRD6BFR 12x100 F59901 KsyElAIRDCLFR 12x100

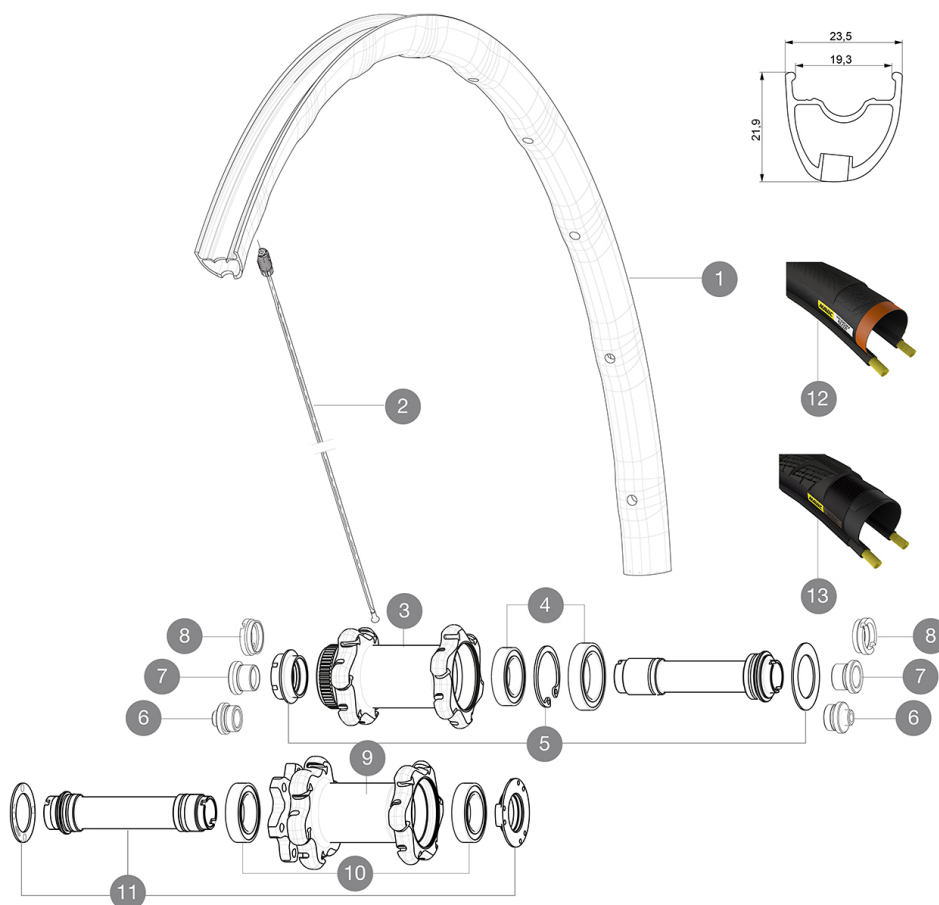

RIMS



&NBSP;:

1	V2405710	KIT FRONT RIM KSYRIUM ELITE ALLROAD
---	----------	-------------------------------------

SPOKES

2	V2273201	KIT 12 FRT/NON DRIVE SIDE BUTTED SPOKE 297mm
---	----------	--

HUB SHELLS

3	N/A	HUB BODY
3	N/A	HUB BODY
4	99688601	BEARING KIT 9/15 DCL HUB 20x32x7 6804 + 25x37x7 6805
5	V2252401	KIT MY16 FRONT AXLE ROAD DISC 9/12/15 CL
10	99688501	BEARING KIT 9/12/15 D6T HUB 20x32x7 6804
11	V2252301	KIT MY16 FRONT AXLE ROAD DISC 9/12/15 INT

TYRES





12	37805628	Yksion EliteGuard White
13	38012230	Yksion Elite Allroad

ADAPTERS

6	B4104301	ADAPTER Ft 9mm QRM+
7	B4104201	ADAPTER Ft 12mm QRM+
8	B4104401	ADAPTER Ft 15mm QRM+

MAVIC Ksyrium Elite Allroad Disc UST

DELIVERED WITH

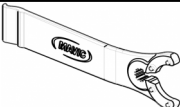
1 bottle of Mavic Sealant (355 466 01) 1	
Front 12 mm adapters (B4104201) 1	
Rear 12x142mm adapters for Instant Drive 360 (B49 896 01 for ID360 6T, B49 899 01 for ID360 CL) 1	
UST valve and accessories (129 838 01)	
Specific disc bolts (308 719 01) Pack of 6	
Multifunction adjustment wrench (325 423 01) 1	
User guide	

COMPATIBILITY

Freewheel: Shimano/Sram, convertible to Campagnolo and XD-R with optional driver bodies	
Front axle: convertible from 12mm thru axle to quick release or 15mm thru axle with optional adapters	
Rear axle: 12mm thru axle, convertible to Quick Release with optional adapters	

Specifications

RIMS

- **Material** : Maxtal
- **Height** : 26mm, asymmetrical
- **Joint** : SUP
- **Drilling** : Fore

Disc brake specific profile

- **Weight reduction** : ISM 4D
- **Valve hole diameter** : 6.5 mm
- **Tire** : UST Tubeless and tubetype
- **Internal width** : 19 mm
- **ETRTO size** : 622x19C

SPOKES

- **Material** : steel
- **Shape** : straight pull, bladed
- **Nipples** : Fore integrated aluminum
- **Count** : 24 front and rear
- **Lacing** : front crossed 2, rear Isopulse

WHEEL HUB

- **Front and rear bodies** : aluminum
 - **Axle material** : aluminum
- Sealed cartridge bearings
- **Freewheel** : Instant Drive 360
 - **Front** : Quick release, 12 thru and 15 thru compatible
 - **Rear** : 12x142 (convertible to quick release with optional adapters)

VERSIONS

- **Color** : Black only
- **Disc standard** : 6 Bolts or Center Lock(R)

WHEEL WEIGHTS

Wheel weight 780