

MAVIC Ksyrium Elite Allroad Disc UST

ASTM CATEGORY 2 : road and offroad with jumps less than 15cm
 Recommended weight limit : 120kg
 Recommended tire sizes: 28 to 42 mm
 Max. Pressure: 28mm 7.7 bars - 110 PSI / 30mm 5.8 bars - 85 PSI

REFERENCES WHEELS

R83001	KsyElAIRD6BRr 12x142	R86701	KsyElAIRDCLRr 12x142
--------	----------------------	--------	----------------------

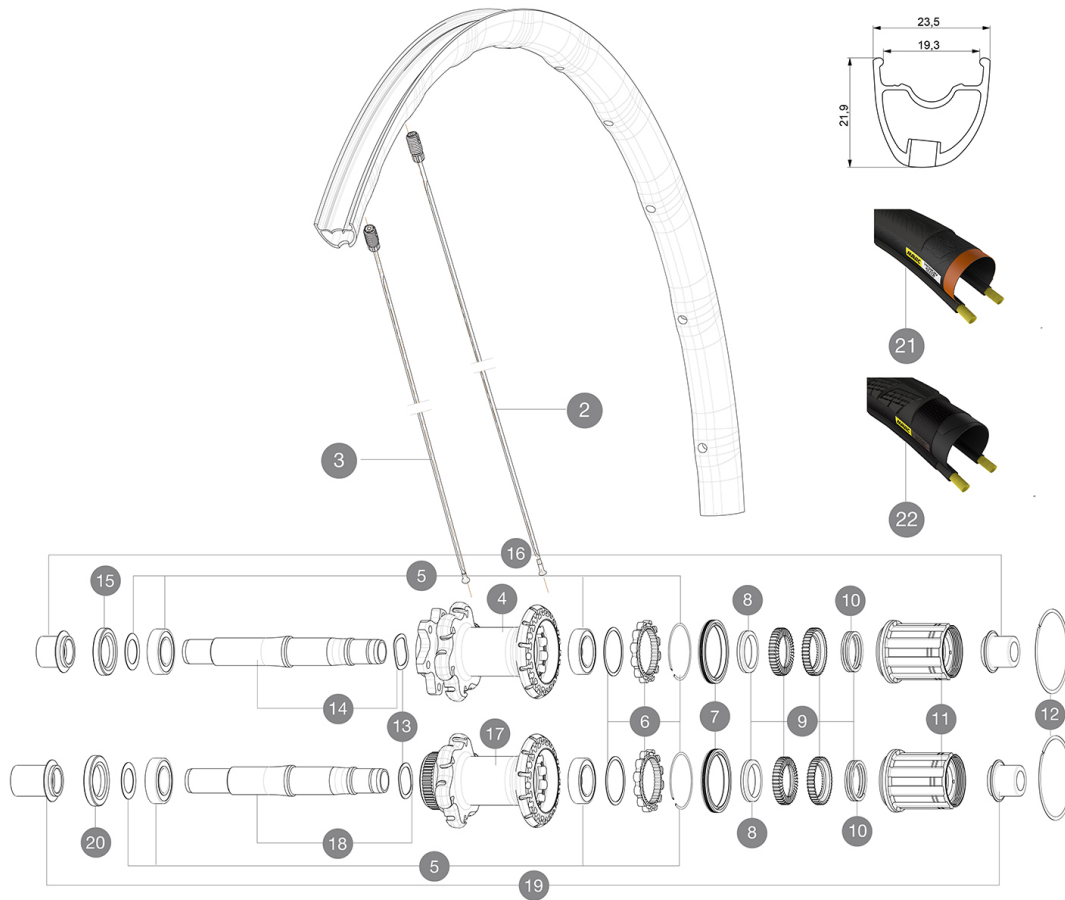

RIMS



&NBSP;:

1	V2405813	KIT REAR RIM KSYRIUM ELITE ALLROAD
---	----------	------------------------------------

SPOKES

2	V2273201	KIT 12 FRT/NON DRIVE SIDE BUTTED SPOKE 297mm
3	V2273301	KIT 12 DRIVE SIDE BUTTED SPOKE 280mm

HUB SHELLS

4	N/A	HUB BODY
5	V2560201	KIT ID360 BEARINGS 15/28/7 + 17/28/7
6	V2252701	KIT ID360 INSERT SHAPED EAR LOBE > 2017
7	V2251601	KIT ID360 SEAL + GREASE
8	V2500501	KIT ID360 3 PADS NOISE REDUCING
9	V2251701	KIT ID360 2 RATCHETS + SPRING + GREASE
10	V2251801	KIT 3 ID360 ROAD SPRINGS
11	V3430101	HG11 Freewheel Body ID360
12	V2252201	KIT 2 REAR HUB RETENTION RINGS 48mm
13	V2251501	KIT 3 ID360 WAVE WASHERS
14	V2251301	KIT ID360 AXLE DISC 6 BOLTS
15	V2251001	KIT ID360 HUB THREADED CAP UB+DISC 6 BOLTS (large) - while s
17	N/A	HUB BODY
18	V2251401	KIT ID360 AXLE DISC CENTER LOCK
20	V2251101	KIT ID360 HUB THREADED CAP DISC CENTER LOCK





TYRES

21	37805628	Yksion EliteGuard White
22	38012230	Yksion Elite Allroad

ADAPTERS

16	B4989601	ADAPTER Rr 12x142mm ID360 (6bolt)
19	B4989901	ADAPTER Rr 12x142mm ID360 (Lock)

DELIVERED WITH

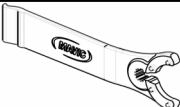
1 bottle of Mavic Sealant (355 466 01) 1	
Front 12 mm adapters (B4104201) 1	
Rear 12x142mm adapters for Instant Drive 360 (B49 896 01 for ID360 6T, B49 899 01 for ID360 CL) 1	
UST valve and accessories (129 838 01)	
Specific disc bolts (308 719 01) Pack of 6	
Multifunction adjustment wrench (325 423 01) 1	
User guide	

COMPATIBILITY

Freewheel: Shimano/Sram, convertible to Campagnolo and XD-R with optional driver bodies	
Front axle: convertible from 12mm thru axle to quick release or 15mm thru axle with optional adapters	
Rear axle: 12mm thru axle, convertible to Quick Release with optional adapters	

Specifications

RIMS

- **Material** : Maxtal
- **Height** : 26mm, asymmetrical
- **Joint** : SUP
- **Drilling** : Fore

Disc brake specific profile

- **Weight reduction** : ISM 4D
- **Valve hole diameter** : 6.5 mm
- **Tire** : UST Tubeless and tubetype
- **Internal width** : 19 mm
- **ETRTO size** : 622x19C

SPOKES

- **Material** : steel
- **Shape** : straight pull, bladed
- **Nipples** : Fore integrated aluminum
- **Count** : 24 front and rear
- **Lacing** : front crossed 2, rear Isopulse

WHEEL HUB

- **Front and rear bodies** : aluminum
 - **Axle material** : aluminum
- Sealed cartridge bearings
- **Freewheel** : Instant Drive 360
 - **Front** : Quick release, 12 thru and 15 thru compatible
 - **Rear** : 12x142 (convertible to quick release with optional adapters)

VERSIONS

- **Color** : Black only
- **Disc standard** : 6 Bolts or Center Lock(R)

WHEEL WEIGHTS

Wheel weight 910