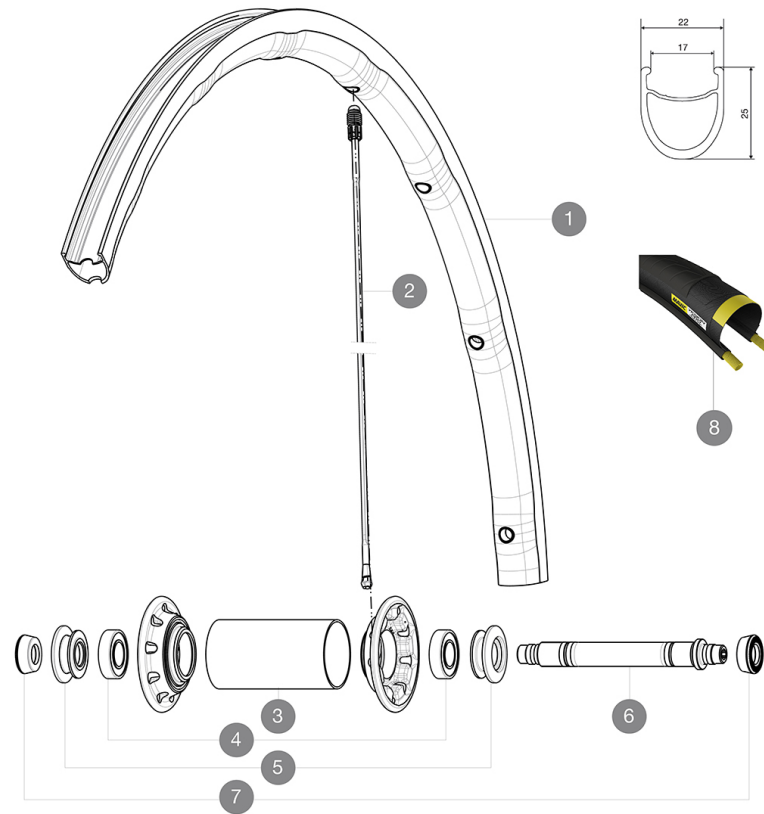

MAVIC *Ksyrium Pro Exalith*

ASTM CATEGORY 2 : road and offroad with jumps less than 15cm
 Recommended weight limit : 120kg
 Recommended tire sizes: 25 to 32 mm
 Max. Pressure: see indication on wheel and tyre. If they differ, use the lower of the 2
 Max. Pressure: 23mm 8.7 bars - 125 psi, 25/28mm 7.7 bars - 110 psi
 Max. Pressure: 25mm 7.7 bars - 110 PSI

REFERENCES WHEELS

F61801 KsyriumProExalith17 Ft

**RIMS**

&NBSP;:

| | | |
|---|----------|-----------------------------------|
| 1 | V2405510 | KIT FRONT RIM KSYRIUM PRO EXALITH |
|---|----------|-----------------------------------|

SPOKES

| | | |
|---|----------|---|
| 2 | V2270601 | KIT 9 FT KSY SLR/K125/PRO EXA SPK 282,5mm |
|---|----------|---|

HUB SHELLS

| | | |
|---|----------|--|
| 3 | N/A | HUB BODY |
| 4 | M40078 | FRONT HUB BEARINGS 6901 x 2 |
| 5 | M40759 | ADJUSTING BEARING NUT + FRONT CAP |
| 6 | 32999801 | FRONT AXLE KIT R-SYS/KSYRIUM SL/SLS 2013 |

TYRES









| | | |
|---|----------|---------------------|
| 8 | 37805325 | YksionProGripLinkWH |
|---|----------|---------------------|

ADAPTERS

| | | |
|---|----------|---|
| 7 | 35117301 | FT/RR FORK REST R-SYS/CC ULTIMATE > 2013/KSY PRO CARB T |
|---|----------|---|

MAVIC Ksyrium Pro Exalith

DELIVERED WITH

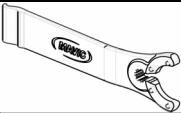
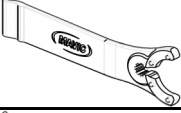
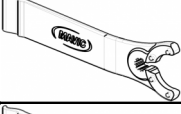
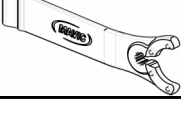
| | |
|---|---|
| BR601 quick releases (V24 501 01 frt, V24 502 01 rear) 1 |  |
| BR601 quick releases (V24 501 01 frt, V24 502 01 rear) 1 |  |
| BR601 quick releases (V24 501 01 frt, V24 502 01 rear) 1 |  |
| BR601 quick releases (V24 501 01 frt, V24 502 01 rear) 1 |  |
| Exalith brake pads (V24 703 01 Shimano/Sram, V24 704 01 Campagnolo) 1 |  |
| Exalith brake pads (V24 703 01 Shimano/Sram, V24 704 01 Campagnolo) 1 |  |
| Exalith brake pads (V24 703 01 Shimano/Sram, V24 704 01 Campagnolo) 1 |  |
| Exalith brake pads (V24 703 01 Shimano/Sram, V24 704 01 Campagnolo) 1 |  |
| Multifonction adjustment wrench (325 423 01) 1 |  |
| Multifonction adjustment wrench (325 423 01) 1 |  |
| Multifonction adjustment wrench (325 423 01) 1 |  |
| Multifonction adjustment wrench (325 423 01) 1 |  |
| User guide | |
| User guide | |
| User guide | |
| User guide | |

COMPATIBILITY

| | |
|--|--|
| Freewheel: Shimano/Sram, convertible to Campagnolo with optional driver body | |
| Freewheel: Shimano/Sram, convertible to Campagnolo with optional driver body | |
| Freewheel: Shimano/Sram, convertible to Campagnolo with optional driver body | |
| Freewheel: Shimano/Sram, convertible to Campagnolo with optional driver body | |
| Front axle: Quick Release only | |
| Front axle: Quick Release only | |
| Front axle: Quick Release only | |
| Front axle: Quick Release only | |
| Front axle: Quick Release only | |
| Rear axle: Quick Release only | |
| Rear axle: Quick Release only | |
| Rear axle: Quick Release only | |
| Rear axle: Quick Release only | |

Specifications

RIMS

- Material : Mxstal
- Material : Mxstal
- Material : Mxstal
- Material : Mxstal
- Height : front 24mm, rear 26 asymmetrical

WHEEL HUB

- Rear body : aluminum
- Rear body : aluminum
- Rear body : aluminum
- Rear body : aluminum
- Front body : carbon with aluminum flanges

WHEEL WEIGHTS

Wheel weight 630