

# MAVIC Crossmax Pro Carbon

ASTM CATEGORY 3 : offroad with jumps less than 61cm  
 Recommended weight limit : 120kg  
 Recommended tire sizes: 28 mm to 62 mm (1.1" to 2.5")  
 Recommended tyre sizes: 36 mm to 64 mm (1.4" to 2.5")

## REFERENCES WHEELS

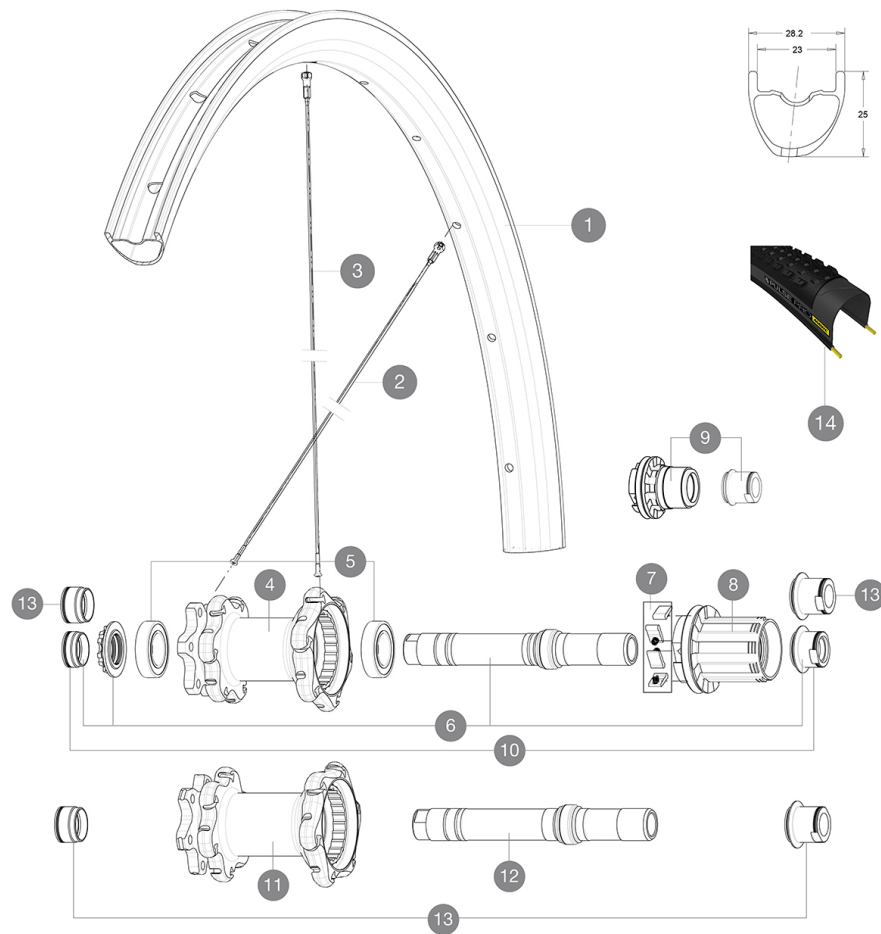

### RIMS



VALVE HOLE (MM): 6,5 :

<b>1</b>	V3090113	KIT REAR RIM CROSSMAX PRO CARBON 27,5"
	V2620101	UST RIM TAPE 25mm (for 21-24mm wide rim)

### SPOKES

<b>2</b>	V2384401	KIT 12 FT/DS CROSSMAX PRO CARB 27,5" SPK 274mm
<b>3</b>	V2384301	KIT 12 DS CROSSMAX PRO CARB 27,5" SPK 272mm

### HUB SHELLS

<b>4</b>	N/A	HUB BODY
<b>5</b>	M40076	HUB BEARINGS 17x30x7 6903 x 2
<b>6</b>	30870401	REAR QRM + AXLE KIT ITS4 135mm from 2012
<b>7</b>	99610601	PAWLS KIT FOR ITS-4 (OR TS-2)
<b>8</b>	99610701	ITS-4 FREEWHEEL SEAL
<b>8</b>	35126001	ITS-4 FREEWHEEL BODY + SEAL 2013 (NO PAWLS)
<b>9</b>	35684101	FREEHUB BODY XD TS2/ITS-4
<b>11</b>	N/A	HUB BODY
<b>12</b>	V2371201	KIT REAR QRM AXLE 135-142 / BOOST 148mm

### TYRES









<b>14</b>	39243121	Pulse Pro 27.5
<b>14</b>	39243132	Pulse Pro 27.5

### ADAPTERS

<b>10</b>	30872201	FRAME SUPPORT ITS-4 135mm REAR AXLE > 2012
<b>13</b>	30859301	AXLE ADAPTER Rr 12x142/148mm Pro Carb MTB (Grey)
	30873101	2 REAR REDUCERS 12/9,5mm 2012 ITS4 HUB

# MAVIC Crossmax Pro Carbon

## DELIVERED WITH

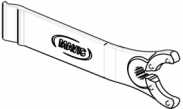
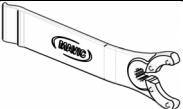
1 bottle of Mavic Sealant (355 466 01) 1	
BX601 quick releases (V24 503 01 frt, V24 504 01 rear) 1	
BX601 quick releases (V24 503 01 frt, V24 504 01 rear) 1	
Front QR adapters (996 941 01 for MTB or B41 043 01 for road) 1	
Front QR adapters (996 941 01 for MTB or B41 043 01 for road) 1	
Rear QR adapters for ITS4 and TS2 (308 731 01)	
Rear 12x142mm adapters for ITS4 and TS2 (308 593 01 for ITS4, 329 650 01 for TS2) 1	
UST valve and accessories (129 838 01)	
UST valve and accessories (129 838 01)	
Specific disc bolts (308 719 01) Pack of 6	
Tubeless rim tape	
Tubeless rim tape	
Multifunction adjustment wrench (325 423 01) 1	
Multifunction adjustment wrench (325 423 01) 1	
User guide	
User guide	

## COMPATIBILITY

Freewheel: Shimano/Sram or XD	
Freewheel: Shimano/Sram, convertible to XD with optional driver body	
Front axle: convertible from 15mm thru axle to Quick Release with included adapters	
Front axle: convertible from 15mm thru axle to Quick Release with included adapters	
Rear axle: 12mm thru axle, convertible to Quick Release with optional adapters	
Rear axle: 12mm thru axle, convertible to Quick Release with included adapters	

## Specifications

### RIMS

- **Material** : 100% Unidirectional carbon fiber
- **Material** : 100% Unidirectional carbon fiber
- **Joint** : SUP
- **Drilling** : traditional
- **Drilling** : traditional

### WHEEL HUB

- **Front and rear bodies** : aluminum
  - **Front and rear bodies** : aluminum
  - **Axle material** : aluminum
  - **Axle material** : aluminum
- Adjustable sealed cartridge bearings

### WHEEL WEIGHTS

- Wheel weight
- Weight Rear 27.5": 790
- Weight Rear 29": 810