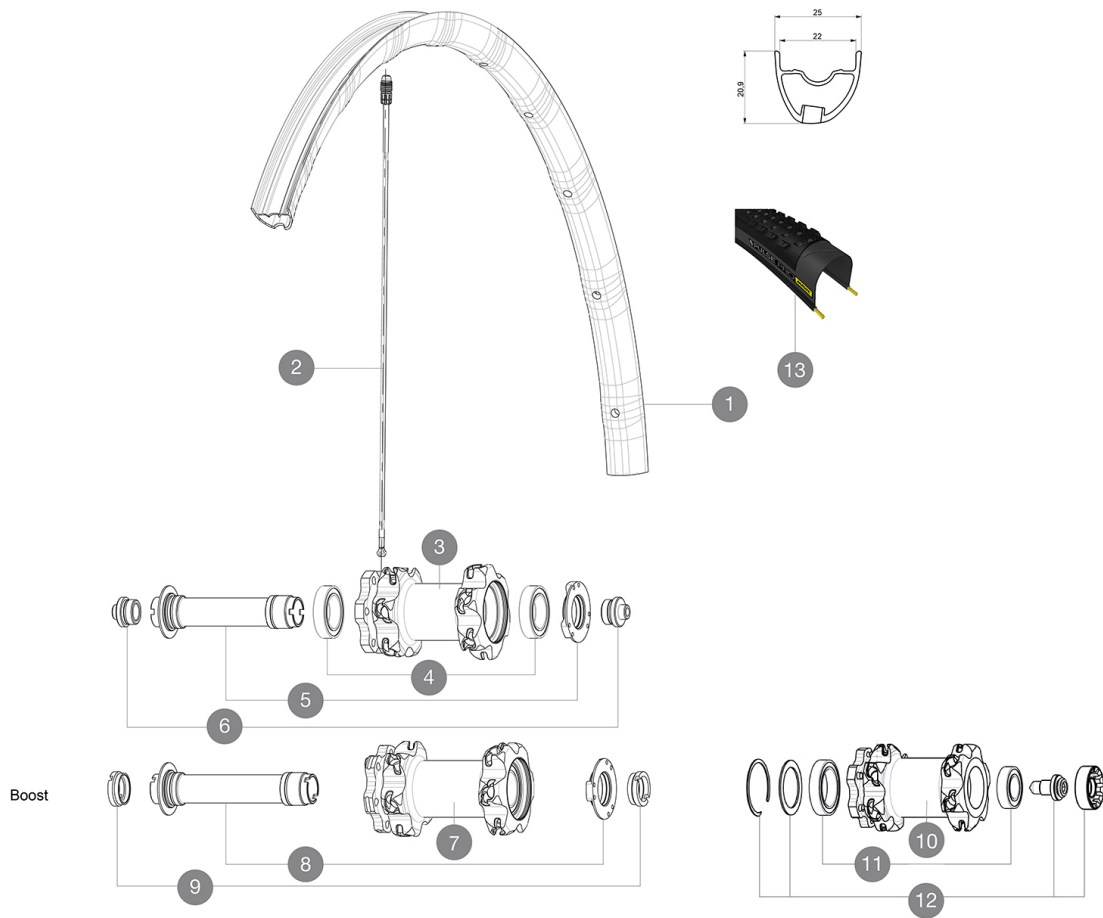

MAVIC *Crossmax Pro 29*

ASTM CATEGORY 3 : offroad with jumps less than 61cm
 Recommended weight limit : 120kg
 Recommended tire sizes: 28 mm to 62 mm (1.1" to 2.5")

REFERENCES WHEELS**RIMS**

VALVE HOLE (MM): 6,5 :

1	V2316210	KIT FRONT RIM CROSSMAX PRO 29" 22mm TSS
---	----------	---

SPOKES

2	V2386401	KIT 1 275mm 27,5" + 1 293mm 29" CROSSMAX PRO STAMPED BUTTE
2	V2384801	KIT 12 FT/ND5 CROSSMAX PRO 29" AL SPK 293mm

HUB SHELLS

3	N/A	HUB BODY
4	99688501	BEARING KIT 9/12/15 D6T HUB 20x32x7 6804
5	V2252301	KIT MY16 FRONT AXLE ROAD DISC 9/12/15 INT
7	N/A	HUB BODY
8	V2370701	KIT FRONT QRM+ AXLE BOOST INTL 110mm
10	N/A	HUB BODY
11	M40771	BEARING KIT FOR LEFTY 50 & 60 HUB
12	36709301	ASSEMBLY KIT FOR LEFTY SUPERMAX WHEELS

OPTIONS

V2650201	ADAPTER Front Torque Cap 15x31 MTB QRM +
----------	--

TYRES









13	39243221	Pulse Pro 29
13	39243232	Pulse Pro 29

ADAPTERS

6	B4104301	ADAPTER Ft 9mm QR QRM+
9	B4104401	ADAPTER Ft 15mm QRM+

MAVIC Crossmax Pro 29

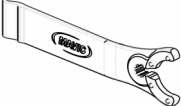
DELIVERED WITH

1 bottle of Mavic Sealant (355 466 01) 1	
BX601 quick releases (V24 503 01 frt, V24 504 01 rear) 1	
Front QR adapters (996 941 01 for MTB or B41 043 01 for road) 1	
Rear 12x142mm adapters for ITS4 and TS2 (308 593 01 for ITS4, 329 650 01 for TS2) 1	
UST valve and accessories (129 838 01)	
UST valve and accessories (129 838 01)	
Multifunction adjustment wrench (325 423 01) 1	
Multifunction adjustment wrench (325 423 01) 1	
User guide	
User guide	

COMPATIBILITY

Freewheel: Shimano/Sram, convertible to XD with optional driver body	
Freewheel: Shimano/Sram or XD	
Front axle: convertible from 15mm thru axle to Quick Release with included adapters	
Rear axle: 12mm thru axle, convertible to Quick Release with optional adapters	

Specifications

RIMS

- **Material** : Mactal
- **Material** : Mactal
- **Joint** : SUP
- **Joint** : SUP
- **Drilling** : Fore
- **Drilling** : Fore
- **Weight reduction** : ISM 4D
- **Weight reduction** : ISM 4D
- **Valve hole diameter** : 6.5 mm
- **Valve hole diameter** : 6.5 mm
- **Tire** : UST Tubeless and tubetype
- **Tire** : UST Tubeless and tubetype
- **Internal width** : 22 mm
- **Internal width** : 22 mm
- **ETRTO size 27.5"** : 584x22ss
- **ETRTO size 27.5"** : 584x22ss
- **ETRTO size 29"** : 622x22ss
- **ETRTO size 29"** : 622x22ss

Hookless profile
Hookless profile

SPOKES

- **Material** : Zicral
- **Material** : Zicral
- **Shape** : straight pull, bladed, double butted
- **Shape** : straight pull, bladed, double butted
- **Count** : 24 front and rear
- **Count** : 24 front and rear
- **Lacing** : front crossed 2, rear Isopulse
- **Lacing** : front crossed 2, rear Isopulse

WHEEL HUB

- **Rear body** : aluminum
 - **Rear body** : aluminum
 - **Front body** : carbon with aluminum flanges
 - **Front body** : carbon with aluminum flanges
 - **Axle material** : aluminum
 - **Axle material** : aluminum
- Sealed cartridge bearings
Sealed cartridge bearings
- **Freewheel** : ITS-4 alloy
 - **Freewheel** : ITS-4 alloy

VERSIONS

- **Color** : Black only
 - **Color** : Black only
 - **Disc standard** : 6 Bolts only
 - **Disc standard** : 6 Bolts only
 - **Hub width** : Boost (front 110, rear 148) or Non-Boost (front 100, rear 135/142)
 - **Hub width** : Boost (front 110, rear 148) or Non-Boost (front 100, rear 135/142)
- Lefty Supermax
Lefty Supermax

WHEEL WEIGHTS

Wheel weight
Weight Front 27.5": 700
Weight Front 29": 730