

ASTM CATEGORY 3 : offroad with jumps less than 61cm
Recommended weight limit : 120kg
Recommended tire sizes: 28 mm to 62 mm (1.1" to 2.5")

REFERENCES WHEELS

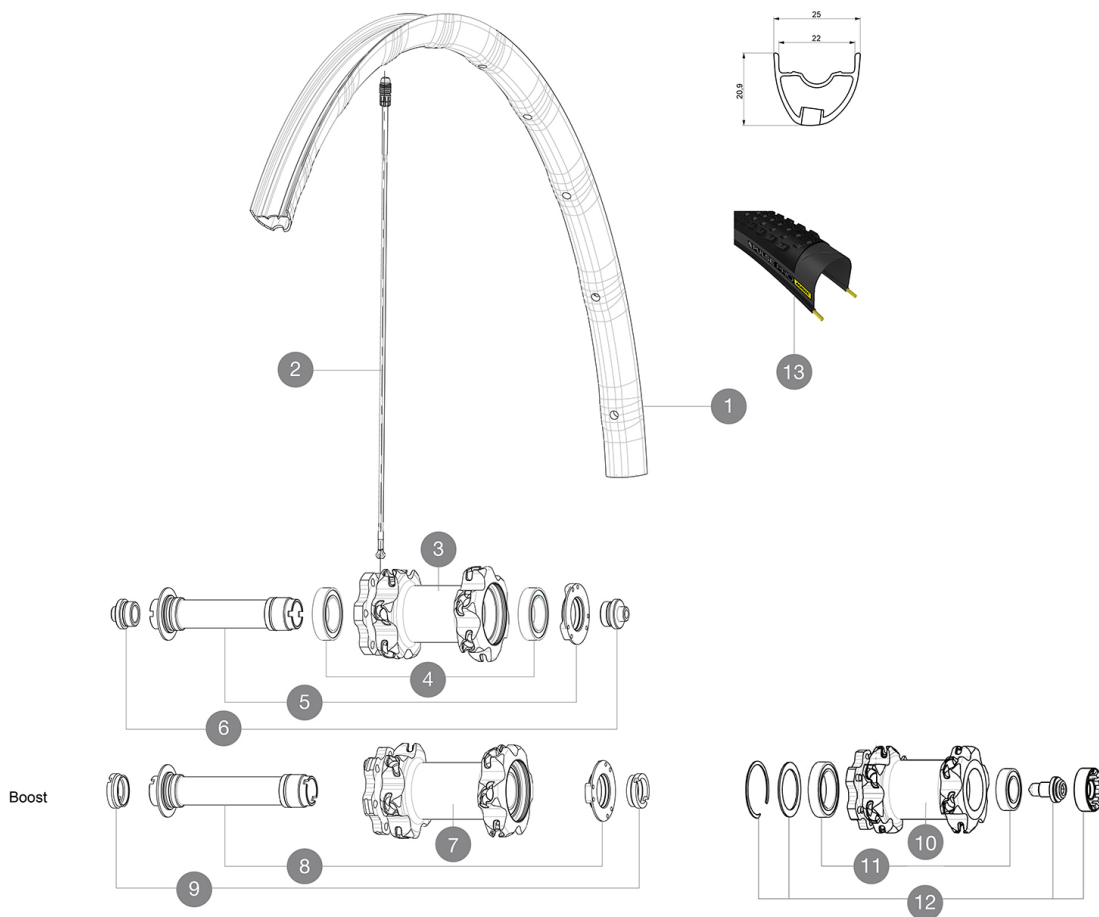

RIMS



VALVE HOLE (MM): 6,5 :

1 V2316210 KIT FRONT RIM CROSSMAX PRO 29" 22mm TSS

SPOKES

2 V2386401 KIT 1 275mm 27,5" + 1 293mm 29" CROSSMAX PRO STAMPED BUTTE
2 V2384801 KIT 12 FT/ND5 CROSSMAX PRO 29" AL SPK 293mm

HUB SHELLS

3 N/A HUB BODY
4 99688501 BEARING KIT 9/12/15 D6T HUB 20x32x7 6804
5 V2252301 KIT MY16 FRONT AXLE ROAD DISC 9/12/15 INT
7 N/A HUB BODY
8 V2370701 KIT FRONT QRM+ AXLE BOOST INTL 110mm
10 N/A HUB BODY
11 M40771 BEARING KIT FOR LEFTY 50 & 60 HUB
12 36709301 ASSEMBLY KIT FOR LEFTY SUPERMAX WHEELS

OPTIONS

V2650201 ADAPTER Front Torque Cap 15x31 MTB QRM +

TYRES







13 39243221 Pulse Pro 29
13 39243232 Pulse Pro 29

ADAPTERS

6 B4104301 ADAPTER Ft 9mm QR QRM+
9 B4104401 ADAPTER Ft 15mm QRM+

MAVIC Crossmax Pro 29

DELIVERED WITH

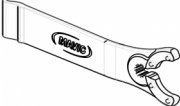
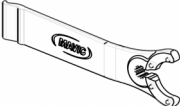
1 bottle of Mavic Sealant (355 466 01) 1	
BX601 quick releases (V24 503 01 frt, V24 504 01 rear) 1	
Front QR adapters (996 941 01 for MTB or B41 043 01 for road) 1	
Rear 12x142mm adapters for ITS4 and TS2 (308 593 01 for ITS4, 329 650 01 for TS2) 1	
UST valve and accessories (129 838 01)	
UST valve and accessories (129 838 01)	
Multifunction adjustment wrench (325 423 01) 1	
Multifunction adjustment wrench (325 423 01) 1	
User guide	
User guide	

COMPATIBILITY

Freewheel: Shimano/Sram, convertible to XD with optional driver body	
Freewheel: Shimano/Sram or XD	
Front axle: convertible from 15mm thru axle to Quick Release with included adapters	
Rear axle: 12mm thru axle, convertible to Quick Release with optional adapters	

Specifications

RIMS

- Material : Mactal
- Material : Mactal
- Joint : SUP
- Joint : SUP
- Drilling : Fore
- Drilling : Fore
- Weight reduction : ISM 4D
- Weight reduction : ISM 4D
- Valve hole diameter : 6.5 mm
- Valve hole diameter : 6.5 mm
- Tire : UST Tubeless and tubetype
- Tire : UST Tubeless and tubetype
- Internal width : 22 mm
- Internal width : 22 mm
- ETRTO size 27.5" : 584x22ss
- ETRTO size 27.5" : 584x22ss
- ETRTO size 29" : 622x22ss
- ETRTO size 29" : 622x22ss

Hookless profile
Hookless profile

SPOKES

- Material : Zicral
- Material : Zicral
- Shape : straight pull, bladed, double butted
- Shape : straight pull, bladed, double butted
- Count : 24 front and rear
- Count : 24 front and rear
- Lacing : front crossed 2, rear Isopulse
- Lacing : front crossed 2, rear Isopulse

WHEEL HUB

- Rear body : aluminum
 - Rear body : aluminum
 - Front body : carbon with aluminum flanges
 - Front body : carbon with aluminum flanges
 - Axle material : aluminum
 - Axle material : aluminum
- Sealed cartridge bearings
Sealed cartridge bearings
- Freewheel : ITS-4 alloy
 - Freewheel : ITS-4 alloy

VERSIONS

- Color : Black only
 - Color : Black only
 - Disc standard : 6 Bolts only
 - Disc standard : 6 Bolts only
 - Hub width : Boost (front 110, rear 148) or Non-Boost (front 100, rear 135/142)
 - Hub width : Boost (front 110, rear 148) or Non-Boost (front 100, rear 135/142)
- Lefty Supermax
Lefty Supermax

WHEEL WEIGHTS

Wheel weight
Weight Front 27.5" : 700
Weight Front 29" : 730